



INSTITUTE FOR DEFENSE ANALYSES

**C2 by Design:
Putting Command and Control Agility
Theory Into Practice
Version 2.0**

**David S. Alberts
Kathleen M. Conley
Waldo D. Freeman
James H. Kurtz
Mark E. Tillman**

September 2015

Approved for public release;
distribution is unlimited.

Log: H 15-000978
IDA Document NS D-5614

INSTITUTE FOR DEFENSE ANALYSES
4850 Mark Center Drive
Alexandria, Virginia 22311-1882



The Institute for Defense Analyses is a non-profit corporation that operates three federally funded research and development centers to provide objective analyses of national security issues, particularly those requiring scientific and technical expertise, and conduct related research on other national challenges.

About This Publication

Version 1.0 of this handbook was produced under the Department of Defense Command and Control Research Program and circulated in August 2014. This version, by the same authors, was completed under the IDA Central Research Program, project number C6414. The views, opinions, and findings should not be construed as representing the official position of either the Department of Defense or the Institute for Defense Analyses.

Version 2.0 incorporates suggestions for improvements from Colonel John Norris, U.S. Army, and several of his staff at the Joint Planning Support Element of the Joint Enabling Capabilities Command under the U.S. Transportation Command, as well as comments received from IDA reviewers, Mr. Michael Leonard and Dr. Kevin Woods.

The authors are indebted to Colonel R.J. Lillibridge, U.S. Army; Colonel Larry Swift, U.S. Army; and Lieutenant Colonel Travis Norton, U.S. Air Force, for contributing vignettes that illustrate C2 Agility during recent operations in Afghanistan, Iraq, and Haiti, respectively.

The changes in the introduction and chapters 1, 3, and 4 are intended to improve clarity. Changes to Chapter 2 are intended to improve clarity and add granularity on the specifics of implementing of a C2 approach and the rationale therefore. Two new vignettes and a new appendix on 7-Minute and 10-Minute Drills have been added, and one appendix has been deleted; the paper otherwise is unchanged from Version 1.0.

Copyright Notice

© 2015 Institute for Defense Analyses
4850 Mark Center Drive, Alexandria, Virginia 22311-1882 • (703) 845-2000.

This material may be reproduced by or for the U.S. Government pursuant to the copyright license under the clause at DFARS 252.227-7013 (a) (16) [Sep 2011].

INSTITUTE FOR DEFENSE ANALYSES

IDA NS D-5614

**C2 by Design:
Putting Command and Control Agility
Theory Into Practice
Version 2.0**

**David S. Alberts
Kathleen M. Conley
Waldo D. Freeman
James H. Kurtz
Mark E. Tillman**

Approved for public release; distribution is unlimited.

Approved for public release; distribution is unlimited.

Preface

This handbook addresses the concept of Command and Control (C2) Agility.¹ The central point of the concept—and of this handbook—is that a unique and tailored C2 approach can and should be associated with every operational approach, normally derived as a product of operational design, and that a significant change in circumstances can and probably should necessitate a change to the C2 approach.² The concept is consistent with and puts into practice the joint command and control fundamentals of Joint Publication 1, (*Doctrine for the Armed Forces of the United States*) (25 March 2013).

Military history provides ample evidence of military commanders achieving success by changing the way they exercised C2. Admiral Nelson’s victory at Trafalgar, for example, depended upon a new operational approach that could not have been implemented without a corresponding change to the C2 methods then in use in the Royal Navy. Rather than insisting on their rigid obedience to signal flags hoisted by his flagship, Nelson delegated substantial authority to his subordinate ship captains, in the process conveying his commander’s intent clearly and concisely:

In case signals can neither be seen or perfectly understood, no captain can do very wrong if he places his ship alongside that of the enemy.³

History also provides instances where failure to recognize that a C2 approach was no longer appropriate may have helped bring about operational failure. Although other factors contributed, the German Army leadership’s continued reliance on a previously successful C2 approach may have helped French-British forces escape defeat at the Battle of the Frontiers in 1914. The earlier C2 approach was based on an assumed level of shared awareness across German forces—a level of shared awareness that failed to materialize as the battle unfolded.⁴

What Admiral Nelson did—and the German high command did not do—was to manifest agility. Agility refers to the capability to operate successfully in the face of changing

¹ This handbook uses C2 for the joint doctrinal term “command and control.” “Mission Command,” which is preferred by the Army and also used in joint publications, encompasses far more than C2 as it is currently defined in joint doctrine.

² An operational design effort may not always be necessary. Time may not permit developing one, for example, or a commander may simply recognize a problem based on prior experience and intuit a solution. However, a skipped or truncated operational design effort may result in a sub-optimal or even inappropriate C2 approach.

³ Lord Nelson to his captains, prior to the Battle of Trafalgar, 21 October 1805. “Quotations, Vice-Admiral Horatio, Lord Nelson,” Royal Museums Greenwich website, accessed 28 July 2014, <http://www.rmg.co.uk/explore/sea-and-ships/in-depth/nelson-a-z/quotations>.

⁴ These and other examples are presented in greater detail in Appendix A.

circumstances.⁵ *C2 Agility* refers to selecting an approach to command and control that is appropriate to the mission, the force and its capabilities, and the operational environment; and making appropriate adjustments when these factors change. Given the growing complexity and dynamism of military operations, *C2 Agility* is, and will surely remain, an important element of the business of command.⁶

⁵ As used throughout this handbook, “circumstances” refers to the mission or task assigned; the organization executing the mission, including forces and capabilities as well as other actors within the commander’s sphere of influence; and the environment in which operations are to take place, to include the capabilities and intentions of opposing forces.

⁶ The terms adaptability and agility are often used interchangeably. This handbook uses the C2 research community’s preferred term, *agility*, which adds the qualities of ease and timeliness to adaptability’s capacity for adjusting in response to changed conditions.

Executive Summary

The aim of this document is to help commanders and their staffs become successful practitioners of C2 Agility. By thinking about and “test driving” the concepts presented here, they should come to appreciate (a) the central role that the C2 approach plays in planning and executing operations; (b) the need to consider the C2 approach as a key operational variable; (c) the differences between and among various C2 approaches and how they align with different circumstances; (d) how to assess whether a change in C2 approach is needed; and (e) how to transition to a more effective approach. By “test driving” C2 Agility in this manner, commanders and staff will begin moving C2 Agility from theory to concept to practice; enabling “best practices” to emerge, be recognized and incorporated into the joint operation planning process, and codified in joint and Service doctrine.⁷

Chapter 1 briefly introduces C2 agility theory and its applicability to operations in complex and ill-structured environments. It introduces the idea, developed throughout this document, that operational design, operational approach, mission command and C2 Agility are mutually-reinforcing constructs.

Chapter 2 demonstrates how the joint operation planning process, outlined in Joint Publication 5-0, *Joint Operation Planning*, leads to an operational approach that can be leveraged to develop a corresponding and complementary C2 approach. The interrelationships among the design, operational approach, and the C2 approach are examined. The C2 approach is then elaborated in considerable detail.

Chapter 3 emphasizes the importance of continuously assessing the C2 approach. It considers assessment at the macro and sub-system level and offers a structure for such assessments.

Chapter 4 discusses the way ahead for C2 Agility and the importance of moving the concepts and their practical application into experimentation, doctrine, and training.

Appendix A includes nine historical vignettes. Seven describe successful operations that depended upon C2 Agility. Two describe operational failures that can be attributed, at least in part, to a lack of C2 Agility.

⁷ The Deployable Training Division of the Joint Staff’s Directorate for Joint Force Development (J7) collects and compares practices among the different headquarters, draws out and refines “insights” and “best practices,” publishes them on the Joint Electronic Library website, and shares them across the operational, training, lessons learned, doctrine, and joint development communities. See the current collection at http://dtic.mil/doctrine/fp/focus_papers.htm (accessed 28 July 2014).

Appendix B introduces a management tool that can be used in a joint force headquarters to ensure that C2 activities are productive and actually support the needs of decision makers.

Contents

1.	C2 Agility Theory.....	1
2.	How to Select and Establish an Initial C2 Approach	7
	A. Operational Design, Operational Approach, and the Commander’s Planning Guidance.....	8
	1. Purposes for Design and an Operational Approach.....	8
	2. Developing an Operational Approach	8
	3. Developing the Commander’s Planning Guidance.....	13
	B. Applying C2 Agility Theory to Joint Doctrine and Operations	15
	1. C2 Agility Theory Applied.....	15
	2. C2 Terminology Mapped to Doctrinal Terminology	15
	C. Relationship between the Operational Approach and C2 Approach.....	16
	D. Elements of a C2 Approach.....	17
	1. Goal of the C2 Function and C2 Approach.....	17
	2. Relationship between the Circumstances and the C2 Approach.....	18
	3. Linkages.....	19
	4. C2 Activities.....	19
	E. Determining an Appropriate C2 Approach	21
	1. Aligning C2 Activities to Support Decisions	21
	2. Initial C2 Approach Guidance	23
	3. Fleshing Out the C2 Approach	24
	F. Communicating the Initial C2 Approach.....	27
	G. Refining the C2 Approach in Parallel with the Operational Approach.....	28
3.	C2 Assessment	29
	A. Why Assess?.....	29
	B. Assessing the Design	29
	C. Assessing the Operational Approach.....	30
	D. Assessing the C2 Approach.....	30
	1. Assessing the C2 Approach at the Macro Level.....	30
	2. Assessing the C2 Approach at the Sub-system Level	32
	E. Assessment Detects Change; Change Demands Agility	34
4.	A Way Ahead	35
	A. C2 Agility: From Theory to Practice	35
	B. Using this Handbook	35
	C. Moving Beyond a Handbook.....	36
	Appendix A C2 Agility Vignettes	A-1
	Appendix B The 7-Minute and 10-Minute Drills	B-1
	Appendix C Illustrations	C-1
	Appendix D References	D-1
	Appendix E Abbreviations.....	E-1

Approved for public release; distribution is unlimited.

Approved for public release; distribution is unlimited.

1. C2 Agility Theory

This handbook provides a basis for establishing an initial command-and-control (C2) approach and assessing its effectiveness in practice. It is intended to help commanders and staffs see the need for and make dynamic adjustments to the C2 approach, thereby enabling better, more informed decisions at every echelon and along every line of effort. The ideas presented here are intended to complement and supplement joint doctrine regarding command and control. The handbook leverages Joint Publication (Pub) 5-0, *Joint Operation Planning*, and focuses at the Joint Task Force (JTF) level for consistency and ease of presentation.⁸ However, the principles articulated in these pages are applicable at any level of a military organization.

Today's U.S. military forces are expected to cope with challenges ranging from a peer competitor in a traditional 'major combat operation' scenario to asymmetric insurgent groups using hit-and-run and terrorist tactics; to cyber-attacks, either stand-alone or in combination with kinetic attacks; to humanitarian operations, disaster relief, and homeland security. These challenges require an assured capability to conduct the full range of military operations with a variety of partners, in a variety of operating environments, and under a variety of conditions. Such operations will normally be joint, and often will include inter-agency partners, allies, and other military forces. Complicating matters further, non-governmental organizations and other actors may be attempting to deal with the same challenge in their own ways, independent from the United States and its coalition partners and not subject to direction from the military commander. Complex environmental factors, opposition from a skillful enemy, presence of other hostile groups (perhaps fighting each other), or even just the weather and geography can further compound operational challenges.

This complexity has been widely recognized by the senior leadership of the Department of Defense (DOD), as has the need for greater operational agility among the armed forces. The forces that executed Operation Iraqi Freedom (OIF) and Operation

⁸ To accomplish its mission, a JTF must interact with multiple persons and organizations, only a portion of whom are subordinate, and even among those there may be varying degrees of authority and control. From the JTF commander's perspective, there are four groups that must be harmonized for mission success: the JTF headquarters staff; subordinate commanders (with varying degrees of subordination, defined by their command relationships); other important actors in the area of operations that have no formal connection to the JTF; and actors outside the area that can contribute to or detract from operations (for example by foot-dragging or providing resources). The JTF commander's challenge is to gain consensus among these four groups of actors on what needs to be done to improve conditions (i.e., achieve focus), and then to facilitate the contributions of all four so that all are moving toward the same set of objectives (i.e. convergence) or at least not hindering that movement. In some cases, the JTF commander will be in a supporting role to another lead actor, but the same C2 challenges will be present.

Enduring Freedom (OEF) exhibited many agile behaviors in the face of such complexity, including innovative approaches to C2. However, these manifestations of agility were largely ad hoc and spontaneous. They were not based on deliberate analysis or experimental findings, nor were they validated rigorously in the field or, in many cases, even featured prominently among lessons learned. Consequently, they have not yet been incorporated into doctrine, education, and training.⁹

One major barrier to agility is institutional inertia. For many years the organizational structures and processes for most U.S. forces were based primarily on requirements designed for major combat operations against a conventional threat, with everything else a “lesser included case.” This was also true of generating forces, including the institutional underpinnings such as schools and training establishments. Major adaptations were forced upon the armed forces to meet the requirements of OEF and OIF, and now, after more than a decade of rotational deployments to the same theaters, often to the same locations, the Cold War paradigm has been replaced. U.S. forces have grown accustomed to conducting counterinsurgency and counter-terrorism operations, supported by extensive intelligence, surveillance, and reconnaissance and robust, mature communications with abundant bandwidth. A different set of missions, for example combat operations against a conventionally armed enemy or humanitarian relief operations in a semi-hostile environment (see Somalia vignette in Appendix A) would require “out of the box” thinking and many changes to what have become the established ways of doing business.

Agility can apply to many dimensions of a military organization, including the organization itself (reorganizing when the situation demands), its equipment, its training, and its basic operational functions (C2, intelligence, fires, movement and maneuver, protection, and sustainment).¹⁰ However, the most important dimension of agility by far is leadership. Without commanders who can recognize when things are not going as planned, challenge their own preconceptions, change their own behaviors, and shape those of their subordinates, there is not likely to be much increase in the agility of organizations or forces. Individual leaders and the organizations to which they belong must be primed for learning and prepared to adapt their C2 approach to complex or ill-structured problems and

⁹ This is not to say there have not been concerted efforts to improve C2 within and among the Services. An example was the first use of a Joint Force Air Component Command (JFACC) in Operation Desert Storm, operating from the Air Operations Center (AOC) at Prince Sultan Air Base in Saudi Arabia. At the same time, the evolution of the AOC is illustrative of how far doctrine can lag behind practice. The AOC became the air command post for the JFACC *at the combatant command level*, yet joint doctrine continues to depict the JFACC as a joint functional component command under a JTF. Desert Storm and Operation Iraqi Freedom were both commanded by the four-star at US Central Command (CENTCOM). The CENTCOM AOC simultaneously supported operations in both Iraq and Afghanistan, and neither of those theater commanders had an air component assigned, nor have JTF commanders in other combatant command areas of responsibility.

¹⁰ Joint Pub 3-0, *Joint Operations*, 11 August 2011, Chapter III.

to the mission and environment at hand, not those they are used to or most comfortable with.¹¹

With OIF and OEF as catalysts, the U.S. Armed Forces have recognized that leadership is paramount and have embraced operational design as an iterative method for analyzing and acting on complex, ill-structured, and dynamic problems.¹² Operational design implies the need to tailor one's approach and behaviors to the problem at hand; therefore, no one-size-fits-all approach exists for joint operations overall or for joint functions like C2. Commanders need to understand whether a particular C2 approach is appropriate to the circumstances they face and how to transition smoothly from one C2 approach to another.

The basic concept of *mission command* is thoroughly consistent with operational design and the development of an operational approach. Joint doctrine defines mission command simply as “the conduct of military operations through decentralized execution based upon mission-type orders.” In his 2012 Mission Command White Paper, the Chairman of the Joint Chiefs of Staff embraced this doctrine and emphasized its applicability to the future operational environment. While the preferred C2 approach is decentralized, with subordinate leaders given freedom to develop their situations and exploit opportunities consistent with the commander's intent, there is need to continually reassess and make changes as necessary to achieve the over-arching purpose. Therefore, “Mission Command is not a mechanical process...instead it is a continual cognitive effort to understand, to adapt, and to direct the achievement of intent.”¹³

Operational design, the concept of an operational approach, and mission command all address the imperative of adapting to changing circumstances and operational demands. Collectively, these inter-related concepts provide a sound context for first developing, and then altering as required, an appropriate C2 approach for a specific set of circumstances. However, these concepts do not deal explicitly with how this should be done. C2 Agility Theory provides a basic methodology for this critical step.

For more than 10 years, C2 Agility Theory in the military context has been studied largely as an academic discipline. In the process, it has produced a solid foundation for practical C2 approaches in real-world operations. With both missions and environments

¹¹ As noted in Army Doctrine Reference Publication 5-0, in the context of operations, an operational problem is the issue or set of issues that impede commanders from achieving their desired end state. Not all problems require the same level of planning. Leaders often identify simple problems and quickly decide on a solution—sometimes on the spot. Design-based planning is critical, however, when a problem is actually a set of interrelated issues, and the solution to each affects the others. ADRP 5-0, *The Operations Process*, 17 May 2012, page 2-2. http://armypubs.army.mil/doctrine/DR_pubs/dr_a/pdf/adrp5_0.pdf

¹² Joint Pub 5-0, *Joint Operation Planning*, 11 August 2011, Chapter III.

¹³ Chairman of the Joint Chiefs of Staff, *Mission Command White Paper*, 3 April 2012, page 4. http://www.dtic.mil/doctrine/concepts/white_papers/cjcs_wp_missioncommand.pdf

expected to vary unpredictably and dynamically in future operations, C2 Agility Theory provides the essential methodology for identifying a C2 approach that best matches the chosen operational approach.

C2 Agility Theory holds that any C2 approach can be reduced and characterized using three fundamental dimensions:

1. How decision rights are allocated.
2. How entities interact with one another.¹⁴
3. How information is distributed.

These three variables form the key dimensions of what C2 Agility Theory calls the C2 Approach Space, and serve to characterize any given approach. The C2 Approach Space can be visualized as a cube¹⁵ (Figure 1). Each C2 Approach occupies its own region—from highly centralized, stove-piped hierarchies to loosely-coupled networks.¹⁶

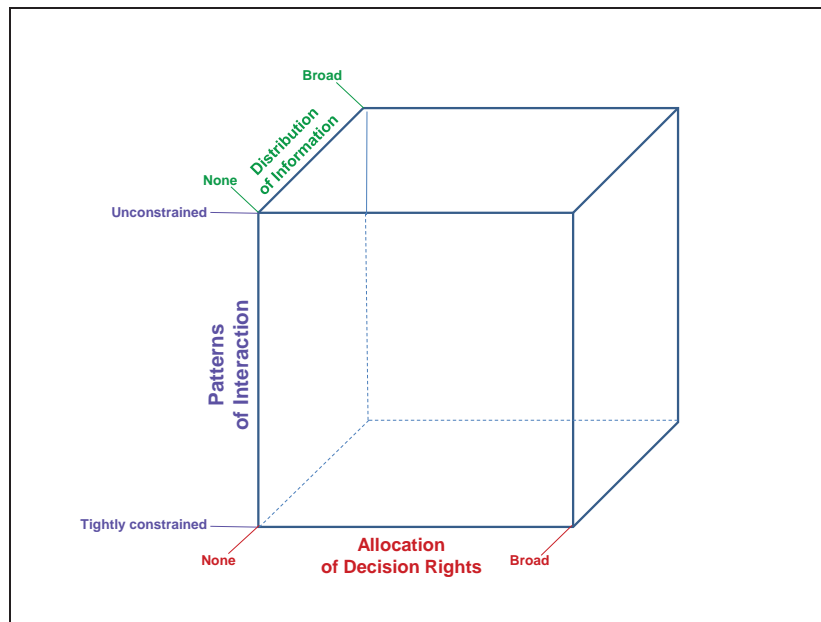

Figure 1. C2 Approach Space

¹⁴ “Entity” is a term used to describe a wide range of actors consisting of individuals or purposeful groupings of individuals within a larger organization or grouping of organizations. In a networked enterprise it can also mean systems, software agents, or other nodes. For the sake of simplicity, this handbook generally uses the more generic term, “actor” or “actors.”

¹⁵ Although depicted as a cube, C2 Agility Theory recognizes that these dimensions are inter-related with, for example, the assignment of roles and responsibilities and with them decision rights determining, in large part, interactions.

¹⁶ David S. Alberts and Richard E. Hayes, *The Future of Command and Control: Planning Complex Endeavors* (Department of Defense Command and Control Research Program, April 2007), 169.

C2 Agility Theory is based upon the premise that missions differ with respect to their complexity and dynamics, and that no single C2 Approach suits all missions, organizations, or environments. C2 Agility Theory holds that the most appropriate approach will be a function of all three, which together constitute the *circumstances*.

Figure 2 illustrates how changes in circumstances may call for changes in the C2 approach. These changes may include a new or modified mission, the emergence or loss of organizational elements (actors, forces, or capabilities), changes in the operational environment (e.g., weather, terrain, enemy) or new approaches taken by familiar actors. Any of these may necessitate a C2 approach that is different from the one first instantiated. Deliberate alterations to the three dimensions that define a C2 approach will yield a new C2 approach, more appropriate to the changing circumstances.

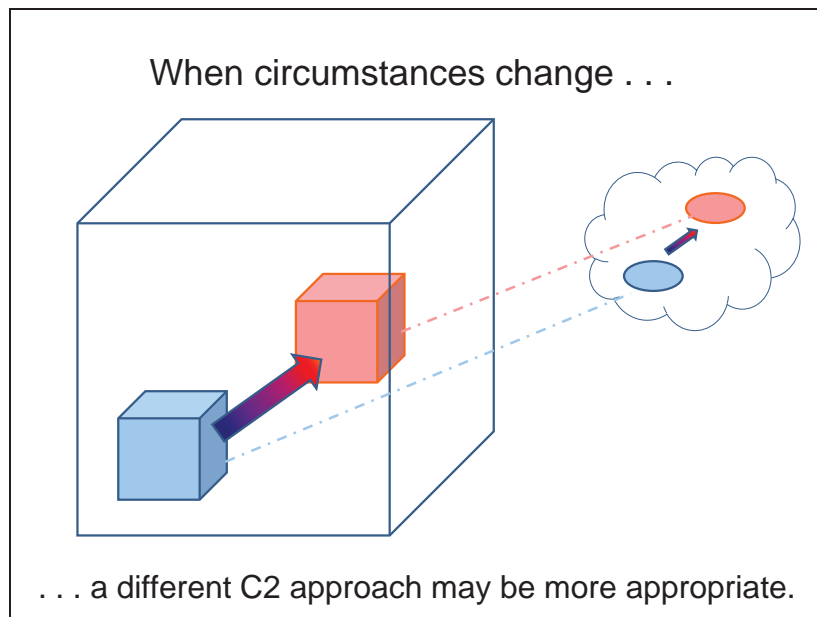

Figure 2. C2 Agility

This ability to move around or maneuver in the C2 Approach Space, to consciously and purposefully alter the way decision rights are allocated, how entities interact with one another, and how information is distributed, is one of the essential ingredients in C2 Agility. The ability to manifest C2 Agility involves:

- recognizing the significance of a change in circumstances (mission, organization, or operational environment) that can impact the appropriateness of the current C2 approach;
- understanding which directions of change along the three dimensions are needed to produce a C2 approach that is more appropriate to the circumstances; and,
- transitioning to the new, more appropriate C2 approach (Figure 3).

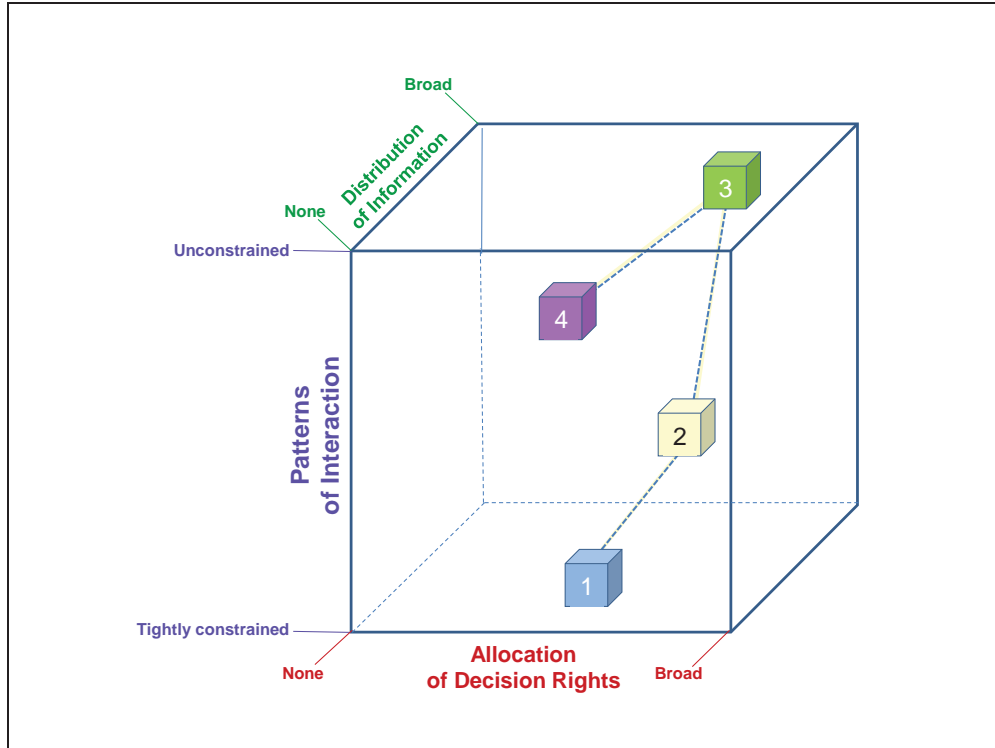

Figure 3. C2 Agility is Intentional Movement within the C2 Approach Space

In summary, operational design, operational approach, mission command, and C2 Agility are mutually reinforcing constructs. In combination, they provide a sound framework for developing an initial C2 approach tailored to the mission, the forces or capabilities available, and the operational environment. These constructs also encourage commanders to alter the chosen C2 approach, replacing it with one that is more appropriate to changing circumstances. Being able to manifest C2 Agility will maximize the prospects of success in future operations. Chapters 2 and 3 build upon this basic explanation of fundamentals.

2. How to Select and Establish an Initial C2 Approach

Joint Pub 5-0 describes how the joint force commander and staff develop plans and orders through the application of operational design and operational art, employing the joint operation planning process. Operational design methodology helps the commander and staff better understand the broad solutions for attaining mission accomplishment and consider the options as they develop an operational approach tailored to prevailing circumstances.¹⁷

Design serves as both a conceptual and practical bridge between the "design team" and the rest of the staff, who must then work to develop the plans necessary to implement the operational approach. In this manner, design helps commanders and staffs determine what they must do. Missing from the design process described in joint doctrine, however, is a set of parallel or complementary activities that focus on determining the most appropriate form of command and control to implement the operational approach. The approach to command and control determines how the operational approach is managed and impacts mission outcomes as much as the operational approach itself (at times, perhaps even more). Failure to consider C2 in the design process can lead to unnecessary impediments to employing available capabilities and can result in a loss of operational effectiveness. If the design process is intended to facilitate and expedite the business of the headquarters as it considers and eventually undertakes the actions deemed necessary to resolve a problem with an appropriate response, then C2 design should be included in that process.

Current doctrine describes how to fashion an operational approach, but not how to determine an appropriate C2 approach, establish it, or assess its execution and effectiveness. The fundamental premise of this handbook is that a C2 approach, developed in parallel with the operational approach as part of operational design and similarly tailored to existing circumstances, can and should be an explicit part of the commander's guidance. This chapter describes how to select and establish an initial C2 approach. The following chapter will discuss how to assess its effectiveness and make adjustments in response to changed or changing circumstances.

¹⁷ Joint Pub 5-0, page III-2.

A. Operational Design, Operational Approach, and the Commander's Planning Guidance

1. Purposes for Design and an Operational Approach

Joint Pub 5-0 lists three purposes for the development of an operational approach and discusses how the planning team uses elements of operational design to inform its development and facilitate detailed planning. First, the operational approach provides the foundation for the commander's planning guidance to the staff and other partners. Second, the operational approach provides the model for execution of the campaign or operation, as well as for development of operational assessments. Finally, developing an operational approach enables a better understanding of the operational environment and of the problem.¹⁸

2. Developing an Operational Approach

The operational approach is "the commander's description of the broad actions the force must take to achieve the desired military end state."¹⁹ Arriving at an operational approach that is appropriate to the mission, capabilities assigned, and the operational environment requires thinking through and answering three broad questions (Figure 4).

¹⁸ Joint Pub 5-0, page III-13.

¹⁹ Joint Pub 5-0, page III-5.

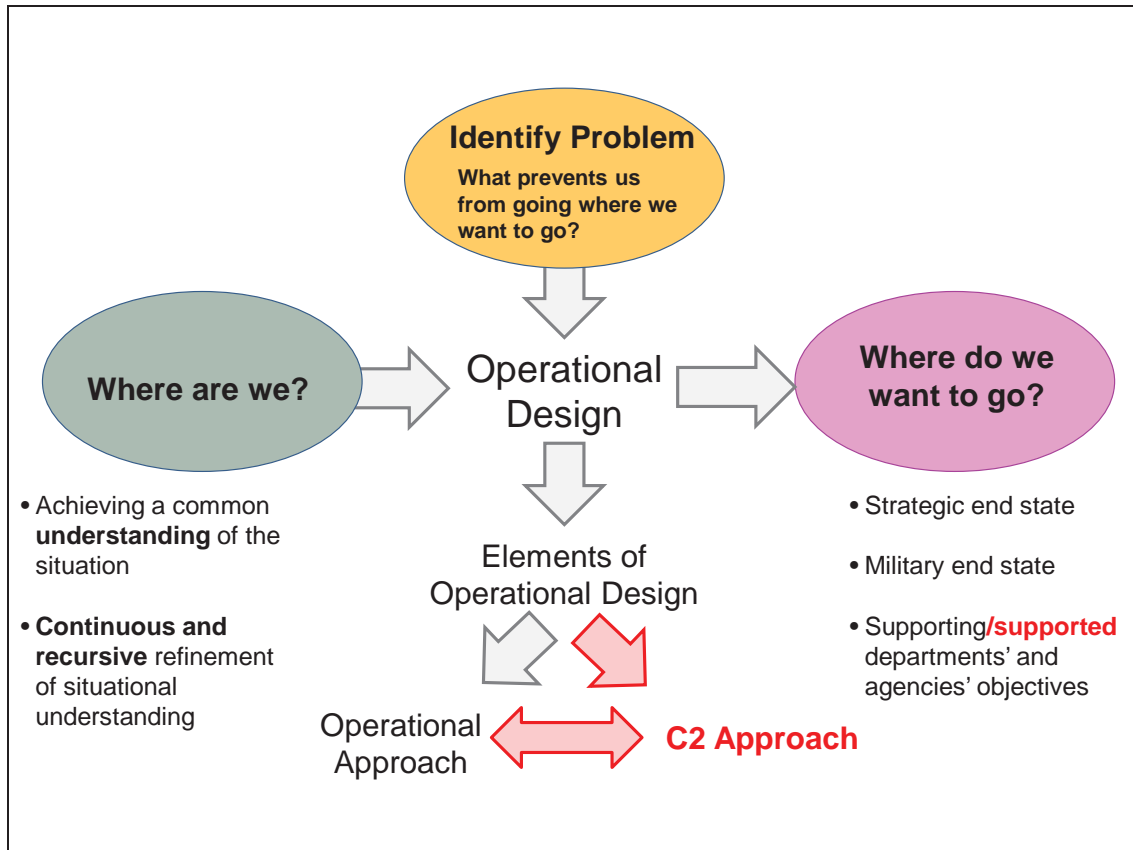

Note: Figure III-2 from Joint Pub 5-0, with modifications in red.

Figure 4. Developing the Operational Approach and the C2 Approach

Developing an operational approach requires an understanding of the operational environment. The commander's description of the current operational environment provides context for and answers the question, *Where are we?*

Developing an operational approach also requires understanding of the strategic direction—in particular the strategic goals to be achieved and the strategic end state desired—the broad expression of the conditions that should exist at the conclusion of the campaign or operation.²⁰ Understanding *why* a particular mission or task is being undertaken is fundamental to understanding the strategic direction. Based on the strategic guidance, the commander will determine the military end state and objectives, which together answer the question, *Where do we want to go?*

The most critical step in operational design is defining the problem to be solved. Commanders may attempt to understand, visualize, and describe the problem based on their prior experience and study. Some may be able to decide almost instantaneously on an

²⁰ Joint Pub 5-0, Figure III-2 and page III-7.

operational approach. However, this is rarely the case for a JTF, and even if a commander believes he can visualize a path forward it would be prudent to apply operational design if time permits, when a problem comprises interrelated issues and the solution to each affects the others. Operational design methodology treats the complete set of problems as a whole. The problem statement identifies the areas that require action to alter existing conditions in the operational environment and move toward the desired set of conditions.²¹ This step formulates the problem statement and answers the question, *What prevents us from going where we want to go?*

In the next step, commanders and planners describe the operational approach as a formulation of how to address the problem. As noted in Figure 4 above, solving a complex or ill-structured problem at the JTF or combatant command level may well involve other U.S. Government agencies with objectives of their own, and the joint force may be assigned a role in support of those agencies. Other actors, such as international organizations and non-government organizations, with which the military force has no formal command relationship and over which the commander has no authority or control, may also be involved, making the problem even more complex and presenting a real C2 challenge to achieving unity of effort.

Determining the Lines of Effort (LOEs) and Lines of Operation (LOOs) that will lead toward the desired end state is key toward designing a campaign.²² Objectives and desired conditions are then arranged onto these lines, and key tasks are generated for the accomplishment of each objective. The resulting framework, as illustrated in Figure 5, depicts what must be accomplished and generally how those accomplishments might be arrayed over time in order to ameliorate the problem. This step begins to answer the question, *What should we be doing?*

²¹ Joint Pub 5-0, Figure III-2 and pages III-12 thru III-13.

²² A LOO defines the orientation of the force in relation to the enemy and connects actions on nodes or decisive points related in time and space to an objective. An LOE links multiple tasks and missions to focus efforts toward establishing strategic and operational conditions. Joint Pub 5-0, page xxii.

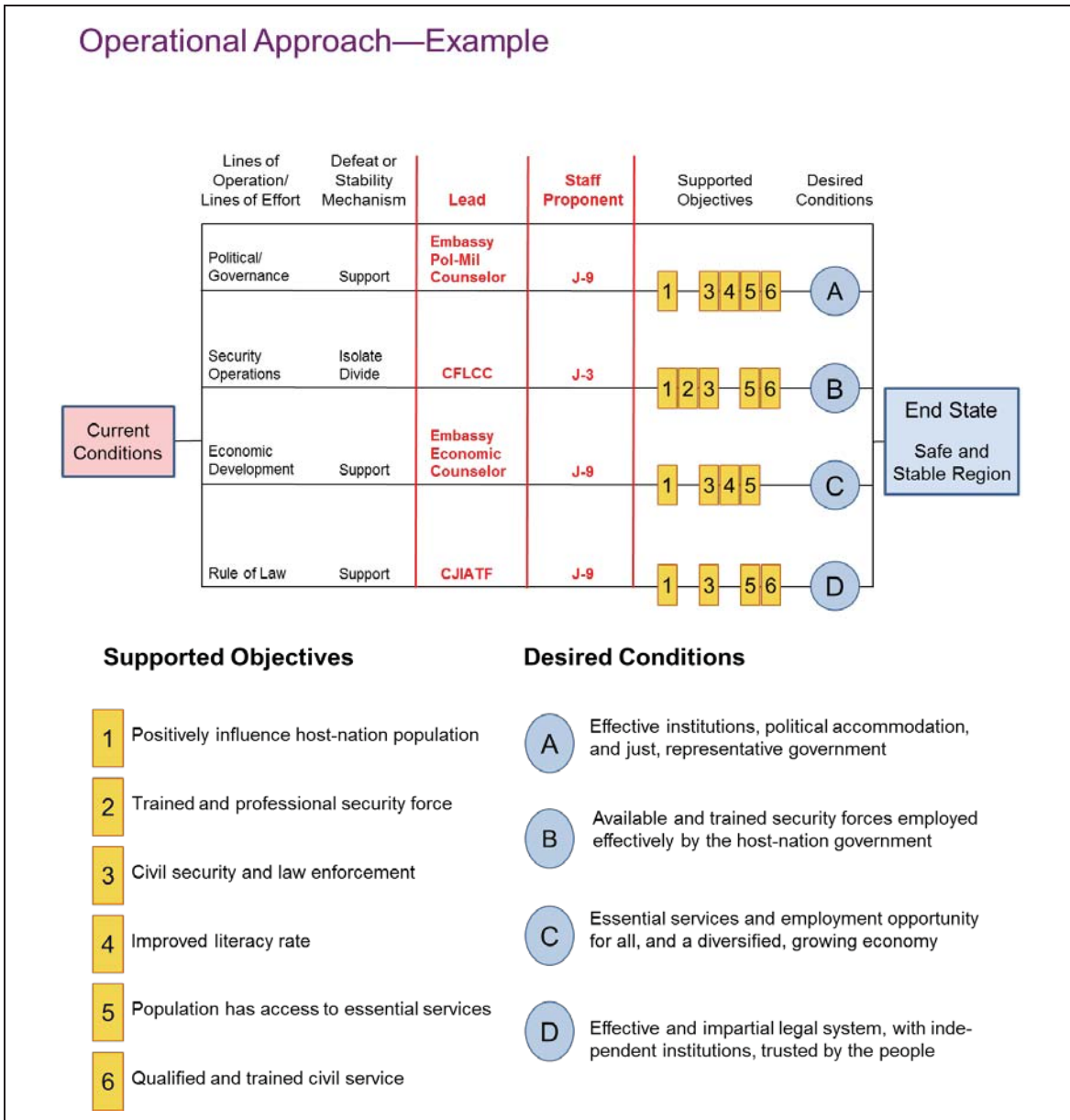

Note: Adapted from Figure III-8 in Joint Pub 5-0. The two added columns in red introduce new C2 considerations, as discussed in the text.

Figure 5. Operational Approach—Example

To achieve the “unique and tailored C2 approach” that C2 Agility theory calls for, the critical first step is to identify who is (or should be) ‘in charge’ of each LOE.²³ It may be

²³ There will be times when no single individual or organization is recognized by all involved parties as being ‘in charge.’ In these cases, it must be understood how decisions will be taken. For example, whether a decision will involve consultations or collaborations and the nature of the processes that will be employed in decision making. There will also be cases when decisions will be taken independently, and it

(Continued)

someone from another department or agency of the U.S. Government, a host nation or an international organization. There may be times when a non-governmental organization is best-suited to 'lead' a particular LOE. Figuring out who to recognize as being in charge, and establishing a working relationship with that person, is essential to developing a C2 approach.²⁴ Once who's in charge of each LOE has been determined, the commander can establish the relationships with each entity necessary to keep all LOEs moving in the right direction, and to avoid a situation where success along one line constrains or otherwise adversely affects another. The nature of the relationship might simply be decided and established by the military commander, but for some entities the relationship is more likely to be negotiated. The classic command relationships of joint doctrine (OPCON, TACON, etc.) may not apply; instead, what some have called HANDCON, a relationship sealed with a handshake, may be the best one that can be hoped for, and may be good enough to de-conflict or even assure unity of effort. Based upon the allocation of decision rights, decisions need to be made regarding what information will be exchanged, how often, and through what means, and how U.S. or coalition military capabilities may best be applied to support actions along the LOE.

The exact nature of each relationship or linkage bears careful consideration. The desired C2 approach may be achieved by posting a liaison team, empowered to speak for the command and to commit resources, at the lead agency's location. Alternatively, the joint force commander may decide to have one of his deputies manage the relationship, or he may assign that responsibility to a subordinate commander. The force commander should normally not assume the lead role for any of the LOOs and LOEs; instead, his job is to oversee them all.

Having determined the lead for each LOE/LOO, the next step is to designate a person or office on the commander's staff to act as proponent for each LOE – charged with monitoring the relationship, ensuring two-way information exchange takes place as agreed, and serving as the point of contact for the LOE lead to report problems and request support.

must be understood whether and how entities will be notified of these decisions so they can act accordingly.

²⁴ When no one is in charge, either everyone is in charge, or non-military Lines of Effort may fall to the military by default. See Christopher Kolenda, "How can we avoid losing more wars? Start by putting somebody in charge of them" at Tom Ricks' "Best Defense" blog on the foreignpolicy.com website, accessed 16 January 2015. <http://foreignpolicy.com/2015/01/13/how-can-we-avoid-losing-more-wars-start-by-putting-somebody-in-charge-of-them/> Accessed 16 January 2015.

3. Developing the Commander's Planning Guidance

Planning guidance may vary according to the commander's personal preferences, but generally includes some combination of graphics and narrative that convey the commander's current understanding of the environment. Guidance should include a narrative problem statement to convey to the staff how the commander understands the problem; a narrative describing objectives, decisive points (geographic places, specific events, critical factors or functions that, when acted upon, will allow the commander to gain a marked advantage over the adversary or will contribute materially to achieving success); and the LOOs and LOEs that describe the operational approach, together with (as noted in Figure 5), the identified lead and staff proponent for each LOO and LOE. In addition to these elements, the commander's planning guidance generally includes the commander's intent. There is no specified format, but a generally accepted construct for commander's intent includes the following:

- The purpose: explains why the forthcoming military action is to be taken, particularly with respect to the mission of the next higher command. When the purpose is well understood, subordinate commanders confronted with unanticipated situations can act decisively and appropriately, in keeping with the commander's intent.
- The end state: describes the strategic end state and the higher commander's military end state, and describes how reaching the specified end-state conditions will support higher headquarters' guidance.
- The operational risk: Defines aspects of the operation where the commander is willing to accept risk, as well as areas where risk is not acceptable.²⁵

Joint Pub 5-0 states that operational objectives, method, and effects guidance may also be included in the commander's intent, but neither Joint Pub 5-0 nor the DOD Dictionary of Military and Associated Terms (Joint Pub 1-02) defines what "method" means. Joint Pub 5-0 comes closest, describing a Course of Action (COA) as "a potential way (solution, method) to accomplish the assigned mission. It goes on to say that:

Since the *operational approach* contains the joint force commander's broad approach to solve the problem at hand, each COA will expand this concept with the additional details that will describe **who** will take the action, **what type** of military action will occur, **when** the action will begin, **where** the action will occur, **why** the action is required, and **how** the action will occur (method of employment of forces).²⁶

²⁵ Joint Pub 5-0, page III-17.

²⁶ Joint Pub 5-0, pages xxvi-xxvii. Italics and boldface in the original.

As previously noted, the premise of this handbook is that a unique and tailored C2 approach can and should be associated with every operational approach, and that communicating the C2 approach can and should be an explicit part of the commander's planning guidance, paralleling the operational approach (Figure 6). However, the "method of employment of C2" cannot and should not even attempt to parallel the method of employment of forces as expressed in a COA.

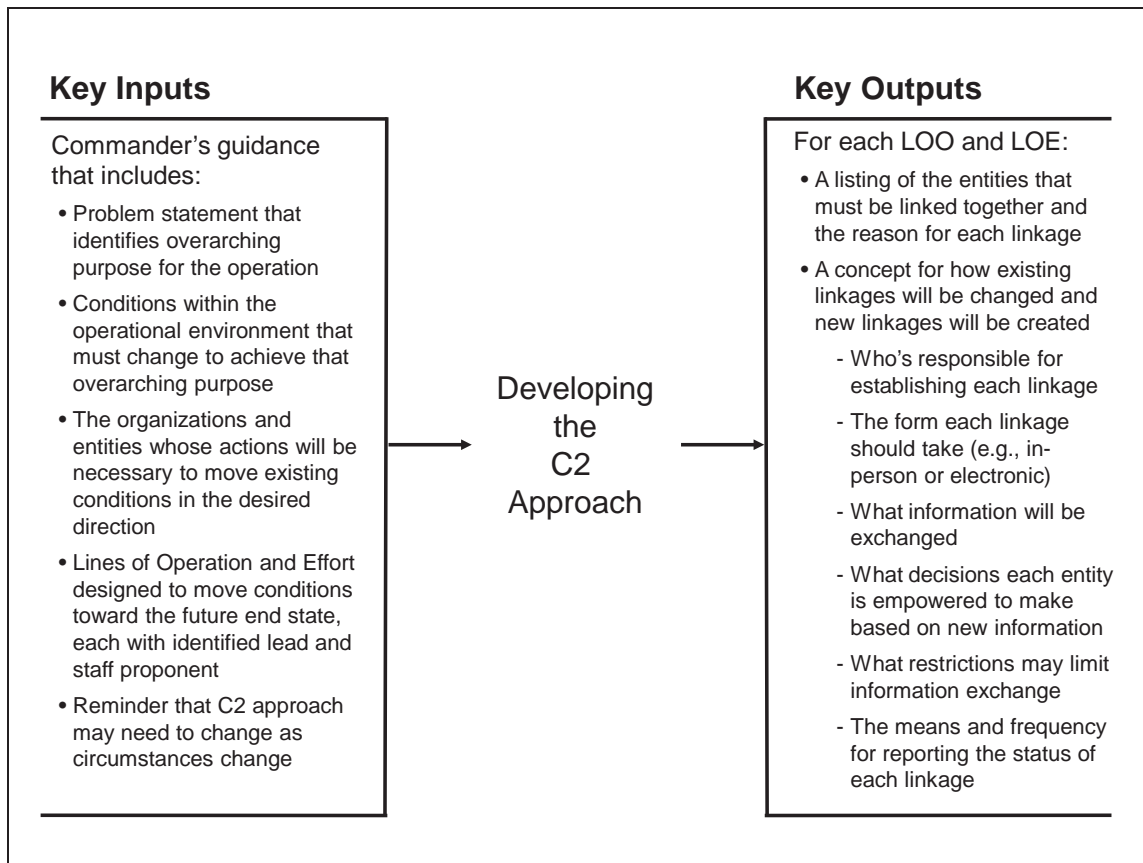

Figure 6. Developing the C2 Approach

In practice, the C2 method should include two specific elements that are critical to fleshing out a C2 approach. The first is the linkages (both internal and external) that describe the organization of the overall endeavor and the network architecture needed to enable the operational approach. The second is the C2 activities.²⁷ Taken together, the

²⁷ In this handbook, the term "C2 activities" includes what Marine Corps Doctrinal Publication 6, Command and Control (1996) calls activities, which include planning, coordination, and analysis, among others (page 126); what Joint Pub 3-0 refers to as tasks, including (but not limited to) 12 specific tasks (page III-2); and what other sources refer to as C2 functions. C2 activities include the full range of processes, tasks, and actions that may be taken to carry out the C2 function.

commander's initial C2 approach guidance and the responses of the staff, subordinate commanders, and mission partners (C2 activities) comprise the "C2 method" — which is here defined as the instantiation of the C2 approach through specific C2 activities as they apply to the C2 approach space dimensions of all the linkages.²⁸

B. Applying C2 Agility Theory to Joint Doctrine and Operations

1. C2 Agility Theory Applied

The central point of this handbook is that a unique and tailored C2 approach can and should be associated with every operational approach. This requires application of C2 Agility theory to the specifics of the operation. The theory does not dictate what to do; rather, it is a guide for thinking about and understanding the C2 variables, subject to a commander's control, that can and should be adjusted to the prevailing circumstances. The circumstances are not theoretical; rather, they are practical. In a military operation, the specifics related to C2 cannot be determined until the commander's intent is made clear. Similarly, the instantiation of an appropriate C2 approach requires details of the circumstances that in turn define the needed linkages and the delineation of, or adjustments to, C2 activities. These are incorporated into a specific C2 approach. The C2 approach then provides the mechanism (i.e., network architecture) by which information, knowledge and understanding can be shared, context can be co-created, and decisions can be made to enable the operational approach.

2. C2 Terminology Mapped to Doctrinal Terminology

Figure 7 below shows terminology associated with joint planning, as found in Joint Pub 5-0, alongside related terms used in this paper. Specifically, where joint doctrine discusses the development of an *operational approach*, this handbook suggests the development of a corresponding *C2 approach*; and where joint doctrine lists operational "method" as an element that may be included as part of the commander's planning guidance, this handbook suggests that in similar fashion, a "C2 method" can and should be articulated to describe the way commanders and staffs are expected to implement the C2 approach. These relationships are further explored in the paragraphs that follow.

²⁸ A "linkage" is a connection between humans, as individuals or as representatives of organizations. A linkage is a relationship that results in comprehension of data and information provided. In contrast, a "link" is used to send data and information from one electronic device to another. The fact that the communications link or data link between two organizations is Green on a stoplight chart does not necessarily mean a linkage has been achieved, because a linkage requires a human being on both ends of the link, comprehending the packets' contents. A linkage may occur in the complete absence of electronic exchanges (in face-to-face meetings, for example).

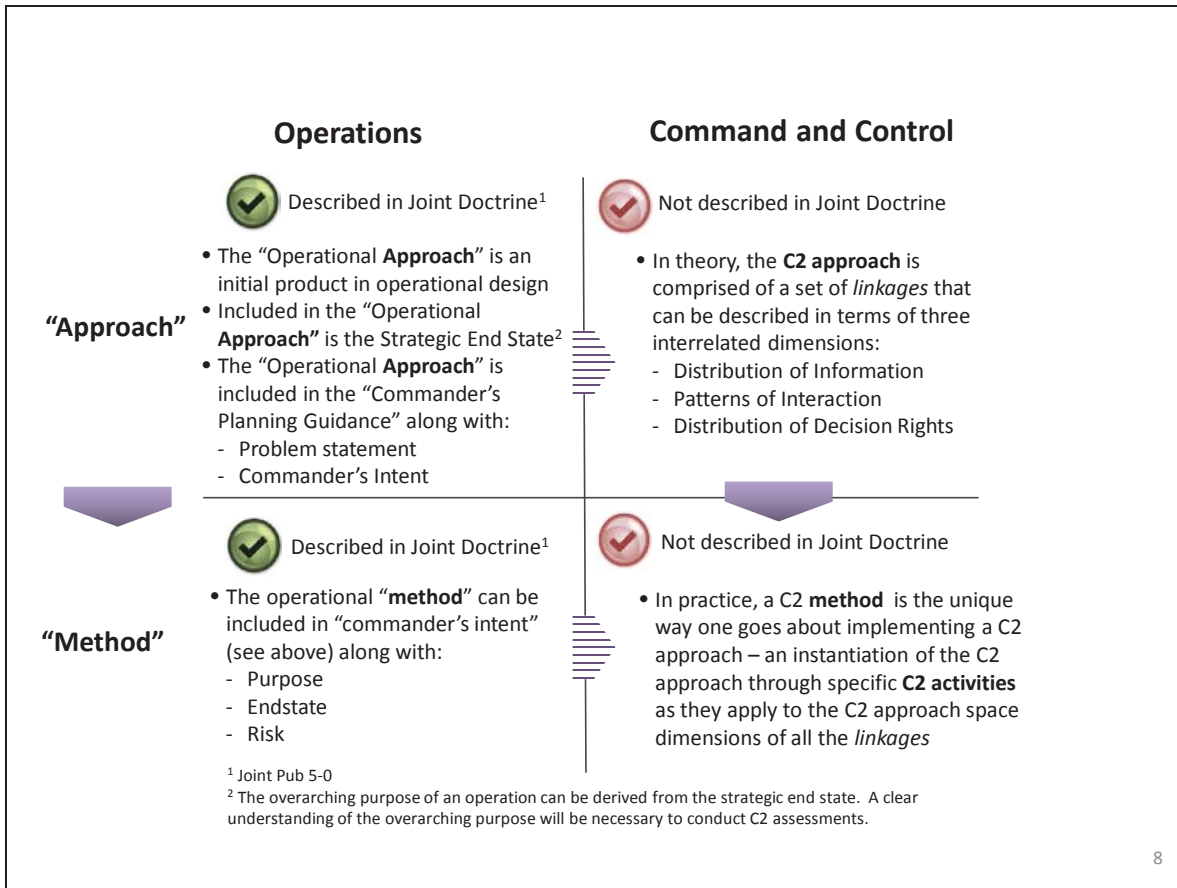

Figure 7. Joint C2 Terms

C. Relationship between the Operational Approach and C2 Approach

As seen earlier in Figure 5, lines of effort assist in visualizing and organizing specific operational actions, by topic in a temporal sequence, while further aligning those activities to specific objectives, desired conditions, and the desired end state. Together, this collective framework constitutes the operational approach. Within the operational approach, the lines of effort serve as the bases for various operational methods that are further described within the commander’s intent and included in the commander’s planning guidance. However, Joint Pub 5-0 does not describe a corresponding *C2 approach* that enables the specific actions along each LOE. As depicted in Figure 8 below, the overall C2 approach can be visualized as wrapping around the operational approach, facilitating the transformation of current conditions to the improved conditions desired at the end state through the provision of informational means that foster suitable, timely decisions that permit both the advancement and integration of the Lines of Effort. Not shown in Figure 8, but necessary to C2, are corresponding C2 approaches for each LOE, developed collaboratively by the designated lead for each LOE and the staff proponent identified by the commander.

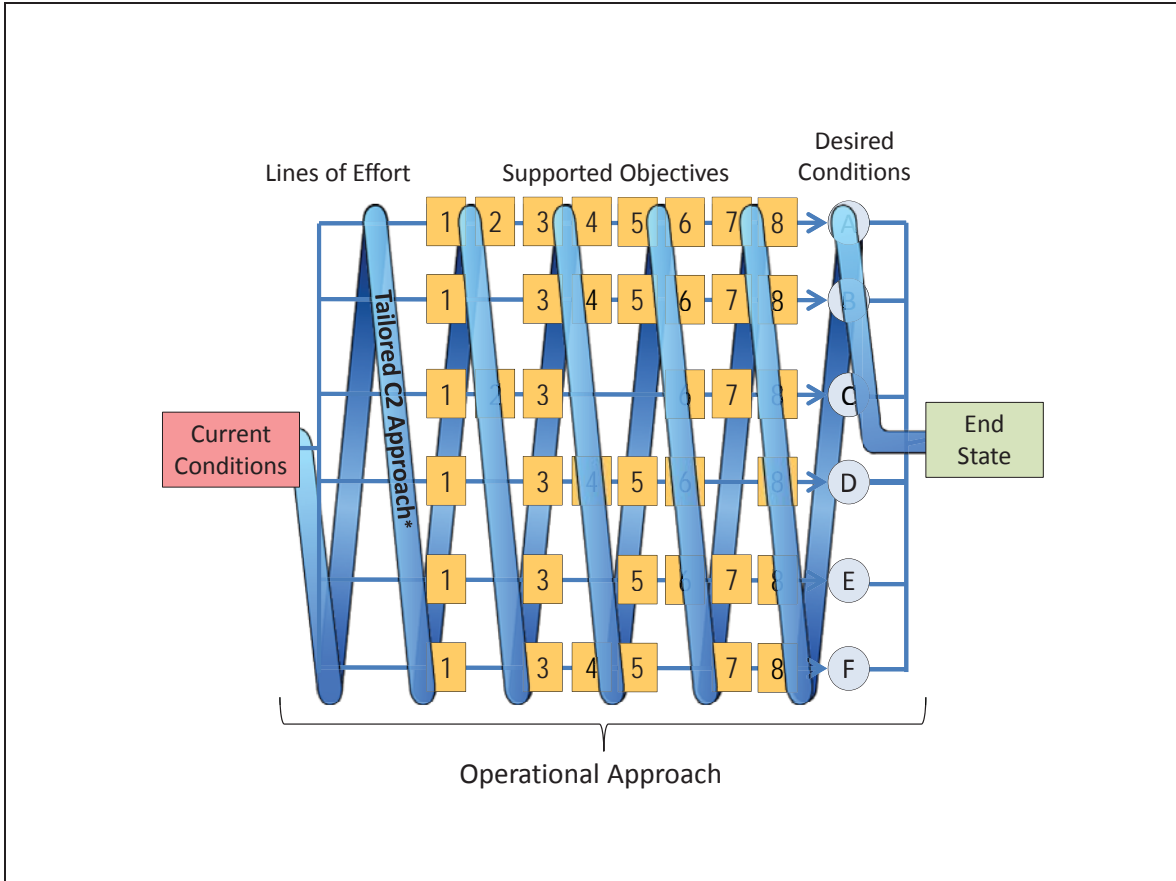

Figure 8. Operational Approach and C2 Approach

D. Elements of a C2 Approach

1. Goal of the C2 Function and C2 Approach

The goal of the joint C2 function is to provide the ability to make decisions and execute those decisions more rapidly and effectively than the adversary.²⁹ Inherent in achieving this goal is the creation of a common understanding of the environment (a “common operational picture”)³⁰ to the extent practicable by sharing information and collaborating on its development and exploitation. Explicitly defining an appropriate C2 approach enables the commander to posture all C2 activities to make and execute sound, timely decisions.

²⁹ Joint Pub 3-0, page III-3.

³⁰ The concept of a common operational picture (COP) has been misunderstood to imply that everyone, regardless of their role and responsibilities, sees exactly the same picture. In fact, a COP enables shared awareness by providing a common and consistent collection of information that can be drawn upon to create views that are tailored to specific needs (sometimes called a “user-defined operational picture”).

As noted in Chapter 1, the C2 approach can be represented as three inter-related dimensions: (a) the allocation of decision rights to *the collective*, (b) the patterns of interaction among the entities; and (c) the distribution of information among *entities*.³¹ What is actually happening on each of these dimensions determines the corresponding position along each, and together they determine a position within the three-dimensional C2 approach space, defining a specific C2 approach.

In practice, every military organization has some sort of C2 approach that is driven by procedures, rules, and standard operating procedures. Wittingly or unwittingly, this default C2 approach defines a default location on each dimension for each entity, both with respect to its relationships to other entities within the parent organization and its relationships with external entities, or actors.³² While not all entities within a collective need to practice the same C2 approach for the collective to be effective, the various C2 approaches practiced should be mutually supportive among entities and echelons and appropriate to the circumstances within which each must operate.

2. Relationship between the Circumstances and the C2 Approach

As previously described, the term “circumstances” includes:

- The operational environment
- The mission or task assigned: Broadly related to the problem to be solved at the operational level, but it can also be much more specific, depending on the organization’s role in fulfillment of the operational approach.
- The organization: The collection of all those entities (actors) necessary to effectively ameliorate the problem, structured appropriately. This usually includes entities outside the direct control of the U.S. military structure. The C2 approach must recognize independent actors and describe how to influence or coerce them to cooperate toward achieving the end state.

Operational design creates a hypothesis as to how to bridge the gap between the current conditions and the end state, which forms the basis for development of the operational approach. A significant change in circumstances usually suggests a change in

³¹ *Entity* is a term used to describe a wide range of actors consisting of individuals or purposed groupings of individuals within a larger organization or grouping of organizations, referred to as *the collective*, with a common and concurrent task or mission.

³² At one extreme it is theoretically possible to interact with no one, share no information with anyone else, and centralize all decision rights unto a single person. It is also possible, in theory, to move to the opposite extreme, where all entities are permitted to interact with everyone else, all information is shared with everyone, and anyone can make a decision on behalf of the entire collective. It is difficult to imagine circumstances in which an approach at either extreme would be effective.

operational approach, which in turn could necessitate a change in the C2 approach. For this, it is less important to know exactly what to do than it is to know (a) the variables (C2 approach space dimensions) that can be altered to change the C2 approach, and (b) the changes along each dimension needed to adjust the C2 approach (e.g., delegate more or less authority, increase or decrease sharing of information, measures to improve relationships and interactions among selected actors). The appropriate changes should be apparent for each C2 linkage. If the C2 approach remains unchanged after a significant change in circumstances, a loss in operational effectiveness may result, placing the achievement of operational objectives and the desired end state at greater risk. Thus, a significant change in circumstances should trigger an assessment of the C2 approach and, if deemed appropriate, purposeful changes to it.

3. Linkages

The C2 linkages are all the human connections among actors in a specific operation. Many may have existed prior to the operation, but normally new relationships or linkages will need to be established—both internal (subordinate) and external (lateral or upward, including supporting and supported organizations, host nation, allies and coalition partners, and international organizations). These can be military or non-military but in each case the modalities that govern the linkage must be confirmed, adjusted, or created to match the existing circumstances and enable the operational approach. Once these linkages have been established, attention needs to be paid to the necessary information exchanges.

4. C2 Activities

While it is possible to visualize and characterize a C2 approach, it can be difficult to recognize the approach actually being practiced at a particular moment without relating it to the corresponding *C2 activities*. These activities provide structure to generate outputs and comprise what commanders, staffs, and the other actors they are linked to are actually doing to exercise C2, which could be (a) the organization's default approach ("the way we always do it"), (b) the C2 approach developed and used for a prior operation, or (c) an approach that develops in the absence of guidance, with actors each "doing their own thing."

The C2 activities become the means by which the C2 approach is executed, just as operational activities are the means by which an operational approach is carried out. Accordingly, an entity's C2 approach can either enable or restrict its C2 activities, whether intentionally or through inertia.³³ Current doctrine contains no exhaustive list of C2

³³ For an example of how changes in C2 activities could have a significant impact on operational effectiveness, see Jenny McFarland, Dan McConnell, Harvey Reed, and John Kane, *Modeling C2 Agility* (Continued)

activities. However, the exemplar list of C2 activities in Table 1 shows a mix of entities, processes, procedures, and products, listed under the various tasks that together comprise the joint C2 function.³⁴

Table 1. Joint C2 Tasks and Exemplar C2 Activities

Joint C2 Tasks and Exemplar C2 Activities
Establish, organize, and operate a joint force headquarters:
<ul style="list-style-type: none">• Operational Design
Command subordinate forces:
<ul style="list-style-type: none">• Decision Authorities Matrix
Prepare and, when required, modify plans, orders, and guidance:
<ul style="list-style-type: none">• Mission Analysis• Orders Process• Plans Synchronization Boards• Transition Mapping Workgroup• Joint Planning Groups (deliberate, crisis action, and adaptive planning processes)
Prioritize and allocate resources:
<ul style="list-style-type: none">• Synchronization Workgroup• Critical Path Synchronization Meeting• Various Utilization Boards• Intelligence Collection/Synchronization Workgroup• Medical Workgroup• Logistics Coordination Workgroup• Aviation Deep Operations Working Group• Joint Transportation Board• Cyber-Electromagnetic Activities Working Group

to Meet the Demands of a Distributed Force, a paper presented at 18th ICCRTS, 26 April 2013:
http://www.dodccrp.org/events/18th_icrts_2013/post_conference/papers/014.pdf.

³⁴ Joint Pub 3-0, page III-2.

Table 1. Joint C2 Tasks and Exemplar C2 Activities Concluded

Joint C2 Tasks and Exemplar C2 Activities
Manage risk: <ul style="list-style-type: none">• Risk Assessment Workgroup• Develop Commander's Critical Information Requirements• Force Protection Working Group
Communicate and maintain the status of information: <ul style="list-style-type: none">• Battle Update Briefings• Commander's Update Assessment• Commander's Azimuth Check• Chief of Operations Synchronization Huddle• Staff Update Briefing• Shift Change Turnover Briefing• Information and Knowledge Management Workgroup• Information Operations Workgroup
Assess progress toward accomplishing tasks, creating conditions, and achieving objectives: <ul style="list-style-type: none">• Assessment Boards• Decision Support Matrix
Coordinate and control the employment of joint lethal and non-lethal capabilities: <ul style="list-style-type: none">• Deliberate and Dynamic Targeting Processes• Targeting Workgroups• Targeting Boards
Coordinate, synchronize, and, when appropriate, integrate joint operations with the operations and activities of inter-organizational partners: <ul style="list-style-type: none">• Operate various centers and cells• Civil-Military Workgroup• Manage Visitors' Bureau• Strategic Communications Workgroup

E. Determining an Appropriate C2 Approach

1. Aligning C2 Activities to Support Decisions

An appropriate C2 approach can be determined after assessing the circumstances (mission or task assigned; organization, or friendly capabilities available; and the operational environment, which includes the enemy) and the linkages and C2 activities

required. Once the C2 approach is chosen or described, commanders and staffs should determine how to conduct C2 activities, given the existing or anticipated circumstances. In this way the C2 activities serve as organizing mechanisms to co-create the needed context and enable a shared understanding.

Ideally, commanders and staffs establish C2 activities to address various information-exchange and other decision-support needs associated with the C2 approach. These needs include setting up the appropriate distribution of information in order to provide a shared understanding constructive to the overarching purpose. Passively awaiting the arrival of needed information is not an effective or efficient use of available time. Instead C2 activities can serve to focus commander and staff efforts in a disciplined, structured, time-sequenced manner in order to collectively raise the level of shared understanding. These C2 activities, shaped by the appropriate C2 approach, should support an efficient and effective decision-making process.

During planning, and as each operation unfolds, every actor (individual or organization) that has a role in the construction or delivery of informational products within a C2 activity (e.g., reports, slides, charts, graphic overlays) should examine the format and content of each product to ensure they actually enhance the decision making process. Conveying information unrelated to current or future decisions may not be helpful and can waste valuable time and cognitive energy of both staff and commander. Conversely, omitting or de-emphasizing information critically important to a decision can derail an otherwise effective operation. All participants should continuously assess the contribution of the products generated by their respective C2 activities in support of effective decision-making.

JTF chiefs of staff have used what is called a “7-Minute Drill” to evaluate the utility of boards, bureaus, centers, cells, and working groups (B2C2WG). While the idea of the “7-Minute Drill” serves a useful purpose, validating a B2C2WG’s placement and deliverables in the headquarters battle rhythm, it falls short of incorporating the ideas discussed in this handbook, and commanders/chiefs of staff may wish to consider creating a separate C2 activity (e.g., a cell) in the headquarters focused on monitoring the C2 approach. Toward that end, the “7-Minute Drill” could be enhanced by infusing a line of questions that form a basis for determining whether C2 activities are aligned and productively contributing to command decision making. The 7-Minute Drill, and a proposed enhancement, notionally labeled the “10-Minute Drill,” are discussed in Appendix B.

2. Initial C2 Approach Guidance

Simply put, command and control can be considered the means by which a commander recognizes what needs to be done and sees to it that appropriate actions are taken.³⁵ The C2 approach, then, serves to shape the way in which the activities associated with C2 are performed. The commander, assisted by the chief of staff, should consider the C2 approach options available in the context of the mission, capabilities available, and operational environment. Then, having selected an appropriate approach to C2, the commander should provide guidance to ensure that the appropriate linkages are established, that appropriate information is being exchanged, and that other necessary adjustments are made to C2 activities. This process is closely akin to and aligns with what the Joint Enabling Capabilities Command and others refer to as Knowledge Management – plans and processes to provide increased situational awareness across the command and to support and enhance the commander’s decision cycle.

At the same time, the commander should recognize and make clear to the staff that the current or intended C2 approach may prove to be inappropriate as circumstances change and may therefore need to be modified as the operation progresses. Guidance should also include the commander’s understanding of the overarching purpose for the ongoing or pending military operation; and, considering this purpose, the commander should describe the scope and breadth of the organizations and other actors whose actions must be harmonized to achieve that purpose.

Others in leadership positions should consider how they are conforming to or supporting the implementation of the selected C2 approach. For example, each LOO and LOE within an operational approach should spawn its own planning effort, and within that effort determine which C2 approach is needed, one that is tailored to the narrower tasks to be accomplished along that LOE. Whether the lead for an LOE is subject to the military commander’s orders or not, the staff proponent should develop C2 approach guidance (in collaboration with the lead, but consistent with the commander’s initial C2 approach guidance) and provide it to the planning team to ensure that planning activities include all appropriate actors charged with achieving objectives along that LOE (and any other actors that may be factors in achieving those objectives). During plan execution, the lead for each LOO and LOE should provide C2 approach guidance to the operational units or actors that are aligned to it (and guidance for dealing with actors not subject to C2 guidance). In fact, every organization that has members reporting to and working together to inform those charged with making decisions, whether those decision makers are in the military chain of command or not, needs to develop a C2 approach of its own, and assess its effectiveness as operations go forward.

³⁵ Marine Corps Doctrinal Publication 6, *Command and Control*, 4 October 1996, page 37.

3. Fleshing Out the C2 Approach

The most important question to ask in developing a good C2 approach is whether the commander and staff understand everything they need to understand about the problem in order to implement the operational approach, whether at the overall campaign level or along an LOO or LOE.

All actors involved in the operation need to ask themselves:

- what are we seeking to understand;
- how does an existing lack of understanding relate to current or planned operations (relevant yet missing aspects of the circumstances and supported decisions), and
- how is it related to decision making?

Additional questions that could point to a more appropriate C2 approach are listed below, each followed by the related C2 approach space dimension(s) in italics. Taken together, these questions can help identify a C2 approach that aligns C2 activities and supporting products to the needs of the commander and others who need information to inform decisions.

- What are the informational needs? *Distribution of information.*
- What is the source of needed information? *Patterns of interaction and Distribution of information.*
- What relationships exist with those that have or are expected to have the needed information? *Patterns of interaction.*
- Do new relationships need to be established in order to obtain the needed information? *Patterns of interaction.*
- What types of information will need to be exchanged and how exactly will the exchange be accomplished? *Distribution of information and Patterns of interaction.*
- Do we have release authority to share this information in the manner expected? Do other actors have the authority to share with us? *Decision rights.*
- Are communications established and tested to ensure information can be shared in the manner expected? *Distribution of information.*
- Are other linkage arrangements needed/established? *Patterns of interaction and Distribution of information.*
- How will this new information be compiled and presented to inform and support decision making? *Distribution of information.*

- How will this information support decisions necessary to enable current or future operations? *Decision rights.*

Figure 9 below, from Joint Pub 5-0, illustrates how various actors (depicted as nodes within each instrument of power) may be interconnected. These actors, many outside the military's direct sphere of influence, may have the information needed to inform a military decision or may need information possessed by the military in order to carry out their responsibilities. It is important to note that the operational approach identifies actors with whom the commander and the staff must interact. These are of two kinds: (a) those with whom a connection already exists (an existing linkage), and (b) those with whom no relationship exists. In the first case, the staff must determine whether the existing linkage is sufficient; in the second, the appropriate linkage must be determined. It may be nothing more than establishing a secure communications link, but it could require the dispatch of liaison teams, direct engagement with key leaders, or some other arrangement.

In one sense, decisions are the most important products of the C2 function [enabled by C2 activities associated with a C2 approach] because they guide the force toward objectives and mission accomplishment. Commanders and staffs require more than just information to make these decisions; more importantly, they need the knowledge and understanding that results in the wisdom essential to sound decision making.³⁶

A shared understanding of the situation, within the commander's organization and among cooperating, supporting, and supported entities, is a critical information-sharing product.

³⁶ Joint Pub 3-0, page III-11 (bracketed text added).

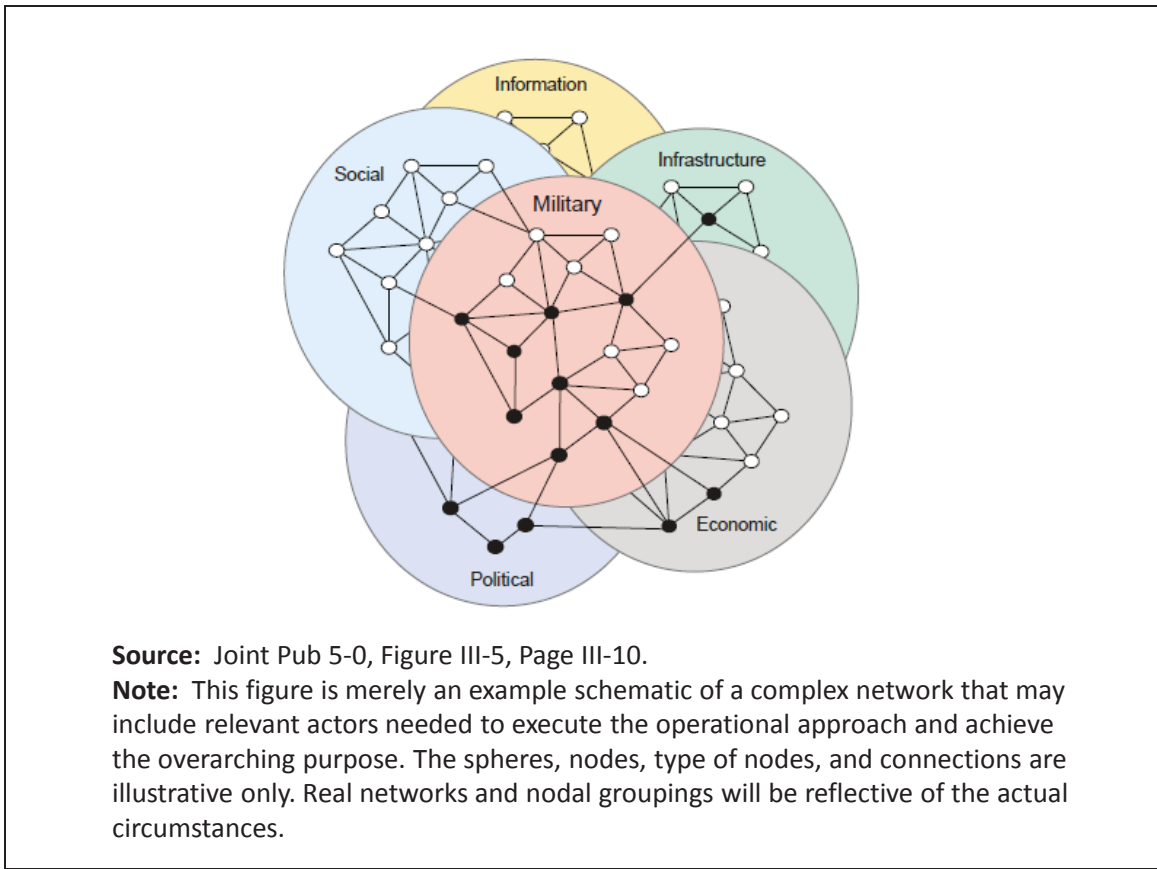

Figure 9. PMESII (Political, Military, Economic, Social, Information, and Infrastructure) System Analysis

The questions posed above should be addressed within the context of the previously developed and directed operational approach, along with the circumstances affecting the operations being conducted. The answers to these questions define the C2 approach actually implemented, which may be different from the one described in the commander's guidance for a number of reasons, including unforeseen constraints, inability to establish linkages, inability to negotiate roles and responsibilities with actors not subject to the commander's control, or simply differing interpretations of the guidance among actors.

As the preceding discussion illustrates, existing C2 structures and activities require continuous assessment and modification in order to assure linkages of the appropriate type with all the actors (including, quite possibly, the enemy or adversary) that can influence attainment of the collective purpose. For each linkage (connection), the three dimensions of the C2 Approach Space must be considered: (a) distribution of decision rights (b) patterns of interaction (collaboration); and (c) distribution of information (information sharing). For entities outside the commander's organization (e.g., non-governmental organizations), linkage arrangements (taskings and rules) must be negotiated, and in some

cases, these may not be completely within the commander's control (such as communicating with the enemy, by words and actions).

F. Communicating the Initial C2 Approach

Communicating the desired C2 approach should include the following:

- A listing of the entities with whom linkages must be established and the reason for each linkage (e.g., to ensure this entity can contribute to progress on LOE A, or can provide information supporting the continued assessment of condition X for decision point Y, or can provide periodic insights needed to validate or refute planning assumption Z). This includes entities with whom linkages already existed (because changes to the linkage arrangements may be necessary) as well as new actors. While it is not possible to predict in advance all the actors with whom linkages will need to be established, directing the establishment or sustainment of key linkages is critical to the shared understanding and co-creation of context needed for mission success.
- Guidance as to how existing linkages should be changed and how new linkages should be created. This guidance should include:
 - Who is responsible for establishing the linkage?
 - A description of the linkage (what should the linkage look like physically – not all need be or can be electronic).
 - When the linkage is necessary.
 - The types of information expected to be exchanged. While it is not possible to predict in advance all the data that will be needed, enabling discovery is key. More specifically:
 - What do we need from the entity?
 - What will the entity need from us?
 - What restrictions, if any, may limit the exchange of information (such as the classification level of the information and any restriction on access to the networks where it resides)?
 - How will this information be provided to the new entity?
 - Which actors have authority to make which decisions based upon new information?
 - The means and frequency (how often) for reporting the status of this linkage (e.g., command communications/assessment update).

G. Refining the C2 Approach in Parallel with the Operational Approach

Given the importance of C2, the C2 approach should be examined not only as part of the design process, but continually thereafter. If a new C2 approach was not established initially, the first issue to consider is whether the C2 approach currently being practiced is adequate for implementation of the operational approach. This will rarely be the case, unless the circumstances happen to exactly match those envisioned when the operation was originally designed.

Even if existing arrangements are assessed as more or less adequate, small adjustments to the C2 approach might serve to better align it with the operational approach and better enable the LOEs and supporting functions envisioned.

Before adopting a new C2 approach, it must be determined whether the selected approach is feasible from both technical and process perspectives.³⁷ Finding, implementing, monitoring and adjusting the 'new' C2 approach is an iterative process that should continue throughout planning and execution of the operation.

Another consideration in the selection of a C2 approach is the C2 activities required to implement it. Are all the existing C2 activities (associated with the 'old' approach) actually needed or have some become superfluous? Do some activities need modifying? Are there C2 activities missing that should be included? These ideas are developed further in Chapter 3.

³⁷ For example, sharing information with partners, especially classified information, is nearly always a problem.

3. C2 Assessment

Once leaders share a common understanding, they are able to direct, lead, and assess. When assessing, it is more important to assess the adequacy of the plan itself rather than just compliance.³⁸

A. Why Assess?

The joint operation planning process (JOPP) as described in Joint Pub 5-0 includes a two-page overview of the assessment process and its importance to success. It states that “assessment and learning enable incremental improvements to the commander’s operational approach and the campaign or contingency plan,” and that “assessments by joint force commanders allow them to maintain accurate situational understanding and revise their visualization or operational approach appropriately.” Finally, “assessment precedes and guides every activity within the JOPP and concludes each operation or phase of an operation.”³⁹ A ten-page appendix on assessment is included in Joint Pub 5-0.

Accepting the critical importance of assessment, this chapter focuses on assessing the C2 approach that is actually being practiced (which may turn out to be different from the one described in commander’s guidance). Normally the C2 assessment is closely tied to, and dependent upon, assessment of the operational approach, which in turn depends upon assessment of the operational design from which it was derived. However, assessing the C2 approach in current use may also reveal flaws in the operational approach that will require appropriate revisions.

B. Assessing the Design

The design effort defines the problem to be solved by developing a postulated understanding of the operational environment based on many assumptions. The assessment of the design is essentially an assessment of the validity and relevance of the assumptions and the resulting understanding of current conditions, propensities, expected responses to stimuli (actions), and ability to move the environment in the desired direction through actions along the LOEs and LOOs included in the operational approach. Design assessment should answer the question, *Is the design working?*

If not, the assessment should lead to changes in the design to reflect a better understanding of interests and forces at work among the entities in the environment, to

³⁸ LTG David L. Perkins, “Developing Competent and Committed Leaders Capable of Executing Army’s Doctrine 2015,” *CGSC Foundation News*, No 15/Fall 2013, page 9.

³⁹ Joint Pub 5-0, pages III-44 thru III-46.

include the enemy. This handbook assumes an ongoing design assessment that informs and improves assessments of the operational approach and the C2 approach.

C. Assessing the Operational Approach

The operational approach, derived from the design, is a visualization of actions along multiple lines. It too is based on assumptions that must be validated by outcomes as the operation unfolds. The operational approach is a set of ideas that comprise the path to attainment of objectives that lead toward the desired end state. The ideas are translated into combinations of concrete actions sequenced over time, which are grouped into LOEs. Assessing the operational approach involves answering two basic questions.

First, *What are we doing?* Are events unfolding as envisioned? Or has something that has happened caused a deviation from the original design and operational approach?⁴⁰ If the operational approach was clearly articulated and the LOE events are observable and monitored, this question can be answered. If events are not unfolding as envisioned, the result of the assessment could be an adjustment to a particular LOE or a complete “reboot” of the operational approach to get back on track. If the operational approach is unfolding as envisioned, the second question becomes, *Is what we are doing working?*

For each LOE, and for the operation as a whole, positive outcomes that are observable are expected for each action or set of actions. If the approach is not working, it may be that more than patience or greater effort will get it going. In all likelihood, however, examination of the underlying assumptions may indicate that adjustments to the LOE or the overall operational approach are required.⁴¹

As with design assessment, this handbook assumes an ongoing operational approach assessment that both informs and improves assessment of the C2 approach.

D. Assessing the C2 Approach

1. Assessing the C2 Approach at the Macro Level

As depicted in Figure 5 and described in Chapter 2, the C2 approach is tailored to the overall operational approach and its individual LOOs and LOEs. It is multi-dimensional and multi-level. Thus assessment needs to consider multiple levels: one of the operational approach itself (macro), another at the level of individual LOO or LOE, and another at the

⁴⁰ For example, Iraq in 2003–2004.

⁴¹ For example, Iraq circa 2007. See Thomas R. Ricks, *Fiasco: The American Military Adventure in Iraq* (New York: The Penguin Press, 2006) or Bing West, *The Strongest Tribe* (New York: Random House, 2008).

level of cross-cutting battlefield functions (such as fire support or intelligence) and activities affecting more than one LOO/LOE (sub-systems).

The first step in assessing the C2 approach at the macro level is to understand what it is supposed to be. This includes the desired relationships with other actors (i.e., the linkages), the desired information flows, and the expected collaboration and decision rights that enable actions and activities overall and along each LOE.

The next step is to ascertain what is actually happening, *Is the C2 approach as implemented what was intended?* Assuming the intended C2 approach was clearly articulated, the elements of its instantiation should be observable. For example, if the C2 approach requires a new linkage with an actor outside the U.S. military structure, has the relationship with that actor been established, and is the desired information exchange occurring? If the approach required changes to linkages within the U.S. military structure (for example, due to a change in a supporting-to-supported relationship), have they been completed?

Macro assessment should also address the question, *Is the C2 approach working?* Even if the C2 approach has been implemented as initially envisioned in the commander's guidance, it may be incomplete, the expected outcomes may not pan out, or the environment itself may change as the result of friendly actions, enemy actions, or the actions of neutral actors over whom the military commander has no control. Fixing problems with the C2 approach requires re-examining the operational design, the operational approach, and the C2 approach to determine the underlying rationale. This step, coupled with learning from ongoing operations, may require adjustments to the C2 approach.

Assessment at the macro level is not simply a series of stoplight charts reporting the status of communications links. Rather, it is an assessment of whether the C2 approach is aligned with, and supportive of, the operational approach. This requires a deeper look into what is happening in important established linkages, including those that do not exist electronically (such as periodic meetings, exchange of information on paper, etc.) and whether what is happening makes sense with respect to the operational approach. The macro C2 assessment, then, should be designed to answer both questions (*What are we doing?* and *Is what we are doing working?*) in terms relevant to the operational approach, not just traditional C2 metrics.

In addition to the formal assessment, it would be prudent to have a separate red teaming effort. The red team would focus on the operational environment with an eye toward whether the operational approach and C2 approach remain aligned with it. Table 2 illustrates key elements of both macro C2 assessment and macro C2 red teaming.

Table 2. Key Elements of Macro-level Assessment and Red Teaming

Macro Assessment	Macro Red Teaming
<p>What is the intended C2 approach?</p> <ul style="list-style-type: none"> Metric: The C2 plan has observable elements <p>Is the C2 approach as implemented what was intended?</p> <ul style="list-style-type: none"> Metric: Actual C2 structures and activities are observable <p>Is the C2 approach working? Is it enabling both the operational approach as a whole and its individual lines of effort?</p> <ul style="list-style-type: none"> Metric: Bottom-up reporting, not just on linkages but, more importantly, on whether the information flows, collaborations, and decision authorities are healthy and enabling both timely decisions and action. Reporting would be on friendly C2 information requirements 	<p>What has changed or could change in the operational environment that will impact the C2 approach?</p> <p>Example categories:</p> <ul style="list-style-type: none"> Mission change or mission creep Organization (own or external) Actors (more or fewer) LOE (progress or lack of progress) Changes in the enemy situation (positive or negative) or in factors beyond the commander's control that work for against mission accomplishment (such as weather and terrain) Communications security compromises <p>What are the most important changes to address first?</p> <ul style="list-style-type: none"> Consider risk and urgency? <p>How will the most important changes impact the C2 approach?</p> <ul style="list-style-type: none"> What adjustment would be required? <p>What indicators would illuminate change in the operational environment and how can they be monitored?</p> <ul style="list-style-type: none"> How can this be implemented? What are the commander's C2 information requirements

2. Assessing the C2 Approach at the Sub-system Level

C2 at the sub-system level may include any part of what comprises the macro level. This includes any sub-component or sub-network (not in the electronic sense) with two or more actors. The sub-system could be defined by a common function or need to exchange information and collaborate in order to accomplish a common mission or task. Examples include a brigade combat team, a ship, a fire support net, an airborne warning and control system, a sustainment group, a humanitarian relief task force, or a group of key actors collaborating on actions along one LOE. Here, too, assessment of the C2 approach in more detail is important as it can both improve the operation of the sub-system and contribute to the maintenance or improvement of the macro C2 approach.

Assessment at the sub-system level is similar to the macro but is generally simpler because it involves fewer entities and a more focused need for information and collaboration. Because it is simpler, problems are easier to identify. The process parallels what has already been described, but with a sharper focus. Absent not only the details of the design and broad operational approach, but possibly also the C2 approach (depending on the level of the subsystem), it is still possible to make a useful C2 assessment.

The sub-system assessment requires at least a general understanding of the operational approach (upper box in Figure 10 below). Specifically, it requires knowing generally what the ongoing operation is trying to achieve. This includes the overarching purpose and the end state. Additionally, the assessment must be based on a good understanding of how the sub-system fits into the operation (e.g., are we trying to destroy the enemy or compel surrender with minimal damage to infrastructure, and why?). Next, who are the other entities, both habitual and new, that must interact to ensure the sub-system activities are contributing to a successful outcome? Next the assessment requires an understanding of the sub-system C2 approach being used and whether that C2 approach is actually working (box 2).

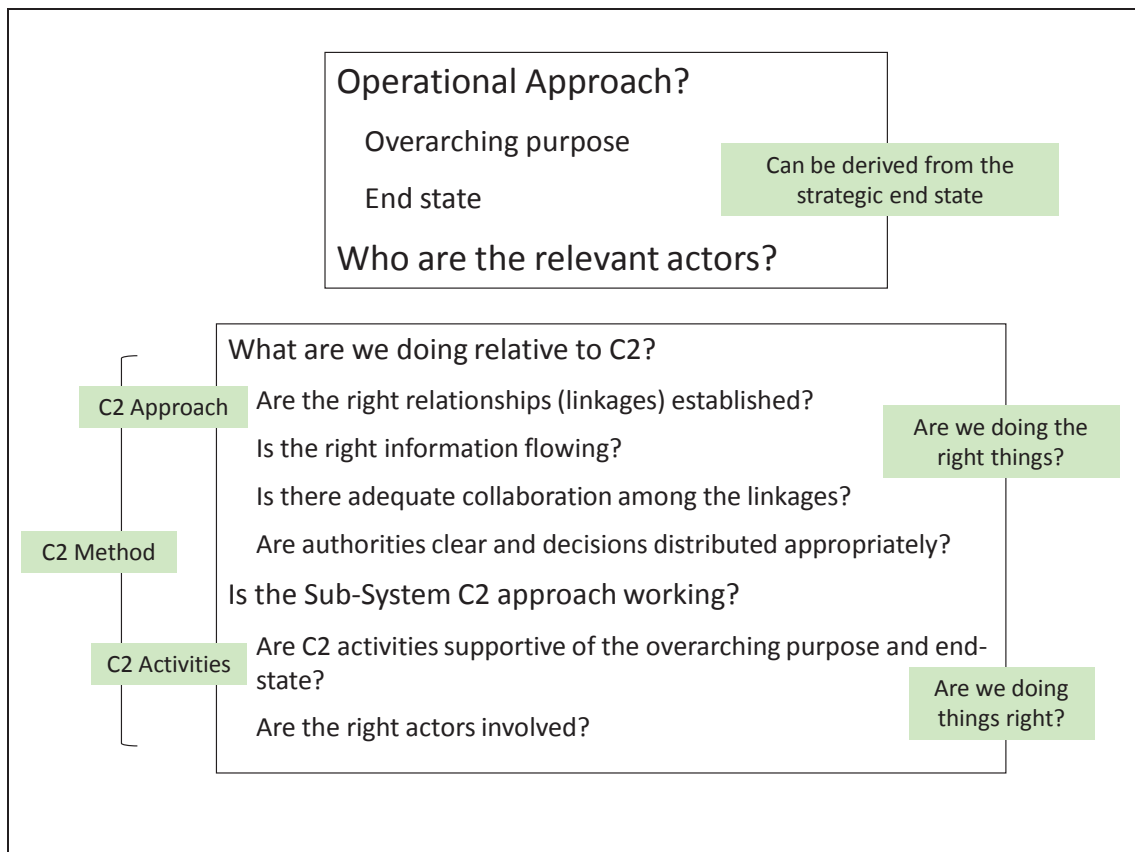

Figure 10. Sub-system Level Assessment

Then, viewing the sub-system as a whole, the C2 approach (Figure 5 above) should be evaluated from the perspective of either the operational approach or the overarching purpose and end state. Three questions help focus this assessment. First, what is the operational approach, if relevant and known to the sub-system? Second, whether the operational approach is known or not, what is the overarching purpose and end state? And third, who are the relevant actors necessary to execute the operational approach or overarching purpose and end state?

With respect to the sub-system itself, another set of questions guides the assessment. The first is, *Does what the sub-system is actually doing or attempting to do relative to C2 make sense?* For example, a fires sub-system re-tasked to take on an additional function (e.g., civil affairs) in a counterinsurgency operation would require significant C2 adjustments. This serves as a check on what is happening with respect to C2 within the sub-system. Four sub-questions will help determine whether what the sub-system is doing makes sense: (1) Are all the right relationships (necessary linkages) established? (2) Are appropriate information flows occurring within each linkage? (3) Is there adequate collaboration between and among actors and linkages to achieve the operation's overarching purpose? (4) Do the right actors in the sub-system have the right decision authorities to achieve the overarching purpose?

If what the sub-system is doing is found to make sense, the next question becomes, *Is it working?* Answering this question necessitates an examination of C2 activities to determine (1) whether they are supportive of the overarching purpose and end state (here it is important to understand whether the C2 activities contribute to building the shared understanding that enables necessary decision-making); and (2) whether the right actors or entities are involved. The answers to these questions will determine whether the sub-system C2 is healthy and, if it is not, where to make changes to improve the sub-system.

E. Assessment Detects Change; Change Demands Agility

Given that design and the resulting operational approach are based on a preliminary understanding of the operational environment, both are subject to change, and very likely to do so. Both require assessment to determine when change is needed, due either to assumptions that prove invalid or to the dynamics of the operation. Similarly, the C2 approach can be expected to change or require modification as events unfold and learning takes place. Thus rigorous and continuous C2 assessment is needed at both macro and sub-system levels to ensure the C2 approach is aligned with and supportive of, the operational approach and its LOOs and LOEs. The vignettes in Appendix A illustrate the importance of assessing whether C2 must be changed to support a new operational approach.

4. A Way Ahead

A. C2 Agility: From Theory to Practice

C2 Agility theory holds that a unique and tailored C2 approach can and should be associated with every operational approach and that a significant change in circumstances can and probably should necessitate a change to the C2 approach. Moving C2 Agility from these ideas, which are supported by a growing body of empirical evidence from lessons learned via recent operations, experiments, case studies, and analyses, to an operational capability, requires a sustained effort over a broad front. It includes engaging all the communities that develop and influence doctrine, organization, training, materiel, leader development and education, personnel, facilities, and policy (DOTMLPF-P). As progress is made, the focus will shift from the research and analysis communities to professional military education, concept development and experimentation, training, systems design and acquisition, and, finally, to the operational community that will determine the state of the practice. This handbook is an important first step toward “operationalizing” C2 Agility, intended to create both awareness of the need for Agile C2 and an understanding of the basics of C2 Agility, thereby preparing commanders at all levels to apply these ideas as a matter of routine.

B. Using this Handbook

This handbook seeks to help commanders and staffs improve their C2 Agility by changing the way they think about and practice C2. The next step is to determine whether, when individuals are exposed to this material, they (a) appreciate why more Agile C2 is needed to meet mission challenges, (b) understand how to determine whether their current approach to C2 is appropriate, (c) are able to identify a more appropriate approach to C2 if one is needed, and (d) know how to transition from one approach to another.

Each of these tasks involves a set of more specific understandings. For example, to appreciate why more Agile C2 is needed, commanders need to understand that an inappropriate approach to C2 can lead to mission failure, as well as to appreciate that the C2 approach being practiced may not necessarily be the same as the C2 approach that was specified in their planning guidance. To assess the appropriateness of the C2 approach currently in use, a commander needs to understand how to think about mission challenges and circumstances, as well as to understand the C2 approach space and which regions of the C2 approach space correspond to various circumstances.

The material in this handbook should be exposed to a variety of experienced practitioners to determine their understanding of C2 Agility concepts, their level of comfort with the changes proposed, and their ability to apply these ideas in practice. Based

on this broad exposure, changes necessary to improve and/or augment the material in the document will be identified, and the handbook revised and expanded accordingly.

C. Moving Beyond a Handbook

Changes in the broader force development environment will be needed to help inculcate understanding of C2 Agility throughout the joint force. While ultimately it will be necessary to look across all of DOTMLPF-P, the initial focus is on the key areas of education, training, and exercises, which could include experimentation with alternative C2 approaches.

With respect to education, officers and non-commissioned officers should be instructed in the principles and methods of C2 Agility. Over the past 15 years, DOD's Command and Control Research Program has produced a wide variety of internationally recognized books, papers, and other materials that instructors have and can continue to use to add to or modify appropriate modules in their C2 courses. Particularly applicable recent CCRP products include two books (*The Agility Advantage*, and *The NATO NEC C2 Maturity Model*); the "NATO SAS-085 Final Report on C2 Agility;" and the "C2 Agility Tutorial" that was presented to the 18th International Command and Control Research and Technology Symposium in 2013.

At a minimum, instructors should describe thoroughly the meaning and value of the three dimensions of a C2 approach: (a) how decision rights are allocated; (b) how entities interact with one another; and (c) how information is distributed. Students should learn how to characterize an existing C2 approach, determine changes in the mission or the environment that could necessitate changes in the existing approach, and change the approach to a more appropriate one in a timely manner. Ideally, joint and Service courses should provide this instruction, but in the absence of such courses, unit commanders should take the lead to inculcate the principles and methods in training their subordinate leaders, drawing on their own experience and case studies as necessary.

Commanders should also see that necessary enablers are in place. For example, they should address cultural factors affecting trust to enable delegation and ensure that unit members have a proper appreciation of how broadly they may have to reach out in their interaction with other parties. In addition, commanders should see to it that the proper technical and procedural means are in place for information-sharing. This means assuring proper interoperability among systems and the establishment of knowledge management procedures so that, when necessary, the information resources of the headquarters and the larger force and set of partners can be fully exploited.

Exercises are an important vehicle for training C2 planners and practitioners at the operational level. Exercises should not just prepare forces for the given mission but also give them a general mindset for thinking in terms of C2 Agility. Mission types chosen can

span the full range of military operations, from peacekeeping to joint and combined air operations against sophisticated defenses. Exercises should be designed to insert sufficient complexity and uncertainty to force consideration of changes in C2 approach. The ability of the force to understand and adapt along each of the three axes of a C2 approach can then be tested in the exercises. Representative assessment factors are:

- **Allocation of decision rights.** Is decision authority being adequately delegated? Is the proper initiative being displayed by those to whom the authority is delegated? Is intent being adequately conveyed, understood, and adjusted as the situation changes?
- **Patterns of interaction.** Are the units engaging with all parties that should be involved in planning and operating? Is this engagement systematic and enduring or is it just ad hoc?
- **Distribution of information.** Are the parties generating information making it adequately available? Can the individuals accessing the information properly assimilate the amounts that may be made available? Is shared context and understanding being achieved?

Lastly, it is important to maintain awareness of the actual state of linkages and C2 activities. Are the actual connections among entities, electronic and otherwise, adequate and fully functional? Are all relevant commander and staff C2 activities operating and are they effective?

Ideally, at a minimum, semi-quantitative metrics should exist for measuring the answers to questions such as the above. These metrics do not exist now, but as exercises are designed, attention should be paid to developing them. Existing methods for designing, conducting, and assessing exercises should provide a starting point.

Finally, it is critically important to understand the *implementation risk* associated with changing the C2 approach. It is not enough to specify a new approach; the feasibility of realizing it also must be assessed. For example, has sufficient trust been established to enable increased delegation? Could unacceptable security risks (insider and outsider) be introduced by allowing greater information sharing? A systematic approach for raising and addressing such questions does not exist at this time, but these considerations need to be included in the design and execution of exercises, as described above.

Approved for public release; distribution is unlimited.

Approved for public release; distribution is unlimited.

Appendix A

C2 Agility Vignettes

The vignettes contained in this appendix illustrate C2 Agility or the consequences of failing to be agile. Seven describe successful applications of the concept while two are examples of failure. The vignettes are included in the handbook for four reasons:

- First, they illustrate that even without explicit theoretical underpinnings or the benefit of a handbook, C2 Agility has been demonstrated throughout history. In each of the successful cases, the command had a problem, the solution to which required changes in the way the organization had been conducting C2. The changes were driven by the nature of the operation envisioned, either an implicit or explicitly expressed operational approach. In retrospect, it often seems that the C2 Agility that occurred was bound to happen or not terribly difficult to envision or plan. But in each case there were other approaches that might have been attempted. Matching the C2 approach to the operational approach is not mechanical; rather, it is a highly cognitive endeavor. Every aspect requires careful thought, and implementation often requires overcoming organizational and cultural barriers or resource limitations. The successful commanders didn't just see a need for C2 Agility; they made it happen. The two examples of failure illustrate the consequences of devoting insufficient attention to C2.
- Second, the vignettes are real-world examples of what C2 Agility looks like in practice. They include how the commanders concerned chose to alter their activities, and a snapshot of the transformed approach.
- Third, the vignettes reinforce the logic of the arguments in Chapters 2 and 3.
- Finally, they are easily-remembered stories from which lessons can be drawn and applied in the future, either directly or as a reminder to refer to the handbook.

The nine vignettes are:

A. <i>Nelson's Victory at Trafalgar</i>	A-2
B. <i>Battle of Britain</i>	A-4
C. <i>UNITAF (Unified Task Force) in Somalia</i>	A-7
D. <i>Joint Special Operations Task Force in Iraq</i>	A-12
E. <i>Unity of Effort in Security Force Assistance Operations</i>	A-15
F. <i>Brigade Counterinsurgency Assault, 2005</i>	A-19
G. <i>The Battle of the Frontiers, 1914</i>	A-21
H. <i>Joint Special Operations Air Component – Haiti</i>	A-24
I. <i>Combined Joint Task Force 7 and the Coalition Provisional Authority - Iraq</i>	A-31

A. Nelson's Victory at Trafalgar

The Battle of Trafalgar, fought off the southwestern Spanish coast on October 21 1805, ranks as one of the most decisive naval engagements in history. The British fleet under Admiral Nelson, with 27 ships of the line, defeated the combined fleet of 18 French and 15 Spanish ships of the line commanded by Admiral Villeneuve, capturing or sinking 22 while losing none.⁴²

The battle was the culmination of a protracted effort⁴³ to draw the combined French and Spanish fleets into a decisive engagement that would change the strategic balance in favor of Britain and its allies during the Napoleonic Wars. The British strategic objective was to so weaken the French and Spanish fleets that they would never again be capable of challenging British control of the Mediterranean or Atlantic approaches to Europe, or enabling an invasion of the British Isles. As long as the French and Spanish fleets existed they constituted a threat, one that meant the British Navy was largely committed to keeping them bottled up in Atlantic and Mediterranean ports.⁴⁴

The decisive victory undoubtedly was due in part to the superior seamanship and battle competence of the British crews as well as the high leadership standards exhibited by the ship Captains. But it is likely that the outcome would have been less one-sided, and perhaps even indecisive, had Admiral Nelson not made two critical decisions in advance about how the battle would be fought. These two decisions required thinking outside the box and deviating from what, until that day, had been widely accepted by both sides as conventional naval C2 doctrine.

Due to both the limitations on maneuver of sailing ships and the difficulty of rapidly signaling (with pennants) battle instructions to large formations of ships during this period, the accepted practice when engaging an enemy fleet was to approach the opponent in a single line, one ship behind another. This meant that in the ensuing battle, the fleets were parallel to one another. This tactic had the advantage of allowing all ships to engage with "broad-sides," bringing all the guns on one side of the ship to bear, and it maximized the number of targets. It also facilitated signaling forward and to the rear of the flagship, which normally was positioned near the center of the line. However, if the fleets were of approximately equal size, gaining a decisive advantage was problematic since an opponent could always break off the fight by turning away and withdrawing if it perceived itself to

⁴² Wikipedia contributors, "Battle of Trafalgar," Wikipedia, The Free Encyclopedia, accessed 22 January 20q4. http://en.wikipedia.org/w/index.php?title=Battle_of_Trafalgar&oldid=590724309

⁴³ Julian Stafford Corbett, *The Campaign of Trafalgar*, 2 vols. (London, New York: Longmans, Green and co., 1919. Republished by Nonsuch Publishing, 2005).

⁴⁴ John Keegan, *The Price of Admiralty* (London: Hutchinson, 1988), 21-22.

be losing. If the side with the advantage tried to follow, its control and firepower would be significantly diminished. Thus, most sea battles of the period were indecisive.

Senior British naval officers were well aware of the limitations of their tactics but had not yet conceived of an alternative that would overcome the limitations of their C2 system, which in turn limited their tactical options. For example, in 1800 the official signals book was revised to improve the speed of signaling by flags, but that alone was not sufficient to bring about changes in battle tactics.⁴⁵ Nelson had been ruminating for several years on this C2 limitation and how to overcome it in order to bring about decisive action.⁴⁶ He knew he needed a different tactical concept for decisive battle and a C2 approach that supported it.

Nelson's solution to the tactical problem was to try to cut the opponent's line into thirds by approaching perpendicular to it, in two columns, if possible from the windward. One column, which he would lead, would attempt to break the line by crossing in front of the French flagship, while the second, led by his second-in-command, would cross about a third of the way forward from the rear of the enemy's line. This would take the leading third of the combined fleet out of the battle for an extended period since it took considerable time to turn back and join the fight. The enemy ships in the center would be outnumbered and subject to rapid defeat at which time the rearmost third could be dispatched. Nelson hoped that by attacking the French flagship directly early, its ability to direct its own fleet would be crippled during its fight for survival.⁴⁷ This concept required accepting great physical risk, particularly to the lead ships, and it also risked a C2 breakdown in the confusion following the breaking of the enemy's line.

Nelson knew this concept for decisive action could not be implemented using the customary centralized C2 from his flagship. His solution to the C2 problem was to organize his force and employ a battle concept so that minimal signaling would be necessary, and to take advantage of the superior experience, skill and initiative of his Captains. He relied on their understanding of his intent. To ensure that understanding, in the months before the battle, Nelson had meetings with different groups of his Captains to discuss the new tactical concept and the critical role of individual initiative, while adhering to the overall concept. He wanted to ensure that as the battle developed, each Captain

⁴⁵ This advance had been put to good use by Nelson for his frigates on picket duty during the blockade of Toulon in 1803 (Keegan p. 22). But it was still much too cumbersome and time consuming for use in a major battle.

⁴⁶ He was well aware of Admiral Rodney's successful deviation from standard practice at the Battle of the Saints in 1782, but that had happened due to a sudden shift in winds rather than by design (Keegan, p. 48). There were other examples but each seemed based on unique circumstances, including his own victory in the battle of the Nile in 1798, when the French Fleet was at anchor.

⁴⁷ Corbett, p. 204-214.

would know what to do with his ship⁴⁸ to best contribute to success of the concept without the need for signals. He followed up the meetings by putting the concept in writing for distribution to each ship's Captain.⁴⁹

Nelson's concept accepted the uncertainties of the battle he intended to fight and his inability to exercise centralized control in the traditional way. He admitted that "nothing is sure in a sea fight beyond all others" and he relied on his Captains' initiative to adjust to circumstances by instructing "no Captain can do very wrong if he places his ship alongside that of the enemy."⁵⁰

C2 Agility Summary: Nelson's ruminations (deep thinking) about how to achieve the objective of decisively defeating the combined French/Spanish fleets was akin to the design process. He understood the problem was not the opposing fleet as much as the standard approach to battle, which made decisive outcomes unlikely. His operational (in this case "tactical") approach was to abandon convention by adopting a radically different concept for maneuvering his fleet. Once initiated, this approach to maneuver could not be executed successfully using the 'normal' C2 methods. Instead, Nelson conceived of C2 not dependent on signals from the command ship, but rather relying on command through intent. He had high confidence that his Captains could gain thorough understanding of the concept and plan, through face-to-face discussions that he supplemented in writing. This was underpinned by extraordinary trust among the leaders, expectations of horizontal collaboration and support during the engagement, and understanding that once battle was joined, the individual Captains had all the information needed to make good decisions.

B. Battle of Britain⁵¹

In early June 1940, after the evacuation from Dunkirk, there was fear in England of a German cross-Channel invasion. The Germans considered mounting an invasion, but knew that one prerequisite would be gaining control of the airspace over the Channel and in the landing areas. The Luftwaffe attempted to achieve this but failed, despite having numerically superior air forces. The young British pilots flying Spitfires and Hurricanes normally get most of the credit for defeating the Germans in the air, thereby forestalling a

⁴⁸ To help in distinguishing friend from foe, Nelson's fleet was painted in a distinctive pattern (later known as the Nelson Chequer).

⁴⁹ Corbett p. 204-214 includes a lengthy discussion of the famous memorandum, and provides a copy as an appendix.

⁵⁰ Corbett pp. 271-272.

⁵¹ For a detailed description of the C2 approach, see Michael Korda, *With Wings like Eagles* (New York: Harper Perennial, 2009).

landing attempt. Less well known is the critical importance of the C2 approach that enabled the fighters and ground weapons to be employed with maximum effectiveness, thus compensating for their inferior numbers.

Between 1936 and 1940, the Royal Air Force (RAF) Fighter Command transformed its air defense C2 approach from a loose collection of fighters (open cockpit biplanes without radios) whose tactics were to employ airborne patrols, ground observers with only local reporting, and ground anti-aircraft guns defending key installations into a well-coordinated system that could skillfully orchestrate the air battle. By June 1940, the transformed C2 approach could put the fighters where they were needed, at the critical time; enable rescue of downed pilots; prevent fratricide from the ground; and manage the vital, but highly constrained, associated logistics. The C2 system also masked its presence and importance from German intelligence. In retrospect, this example of C2 Agility seems obvious, but at the time it was controversial with many detractors, both within the RAF, including much of the old school fighter community and the bomber community (which was much better resourced), as well as among politicians. While the system incorporated new technology, its key feature was a new operational approach and a corresponding C2 approach that took advantage of the new technology to knit the pieces together and manage them appropriately.

The pieces included the coastal radio detection and ranging stations (early radar), the ground observers (who supplemented the radars by providing estimated enemy raid strength and altitude), airfields and fighters, the ground air defense units, tethered balloons, and elements of the navy coastal command and air units. Integration efforts included introducing a rudimentary two-way radio in new fighters, developing dedicated telephone links buried and protected in concrete sheathing, and, most importantly, creating an RAF Fighter Command Operations Center. This operations center conducted two new activities: it received reports from the radar facility crews, ground observers, and radio intercepts; and it used the information received to accurately predict the routes, altitudes and targets of German raids. It also shared this information about the developing situation with four subordinate Group Command Centers, thereby enabling them to alert their subordinate airfield (sector) air defenses, determine the best allocation of available fighter squadrons, launch fighters in time to reach optimal altitude, and vector them to intercept the incoming German bombers. Throughout the battle, the Fighter Command Operations Center maintained what today would be called a common operational picture, which it shared with the four groups. The Fighter Command Operations Center also controlled the logistic supply chain from the factories to the airfields, which enabled the four groups to continue operating despite air losses and ground damage suffered during raids.

The groups maintained tactical control of the battle, which involved successfully orchestrating several C2 activities. They determined the response to each raid based on the status of their squadrons, time, expected raid location, the weather, and other factors. The C2 approach also enabled them to request support from adjacent groups if required. Below the group level, a system of sectors was devised to control each airfield and its squadrons. The British airspace was divided into four Groups as shown in Figure A-1.

Initially it was necessary to centralize C2 at the RAF Fighter Command Operations Center and the Group Command Centers because they were the nexus of information needed to respond to a particular set of threats. But once Fighter Command determined the best response, and fighters were launched and vectored by their respective sectors, the fighters could see their targets and determine the best attack options, so C2 of engagement was decentralized. Overall C2 activities continued to support the unfolding operations; for example, the centers helped prevent fratricide by passing the routes and locations of friendly fighters to ground air defense units and naval forces. Operations at each air base (and in each sector) were also decentralized, including launch, recovery, refitting and re-launch, as well as defense.

This process was repeated several times each day as successive waves of German attackers crossed the Channel. Fighters scrambled in response to an earlier wave might still be airborne as Fighter Command was preparing for the next one. Fighters often flew multiple sorties, even when their bases were under attack with their ground crews and base operations exposed (they were located above ground in wooden huts). Fighter Command monitored the status of all fighter squadrons and managed the replacement of aircraft, pilots, and ground personnel on a daily basis as the battle raged.

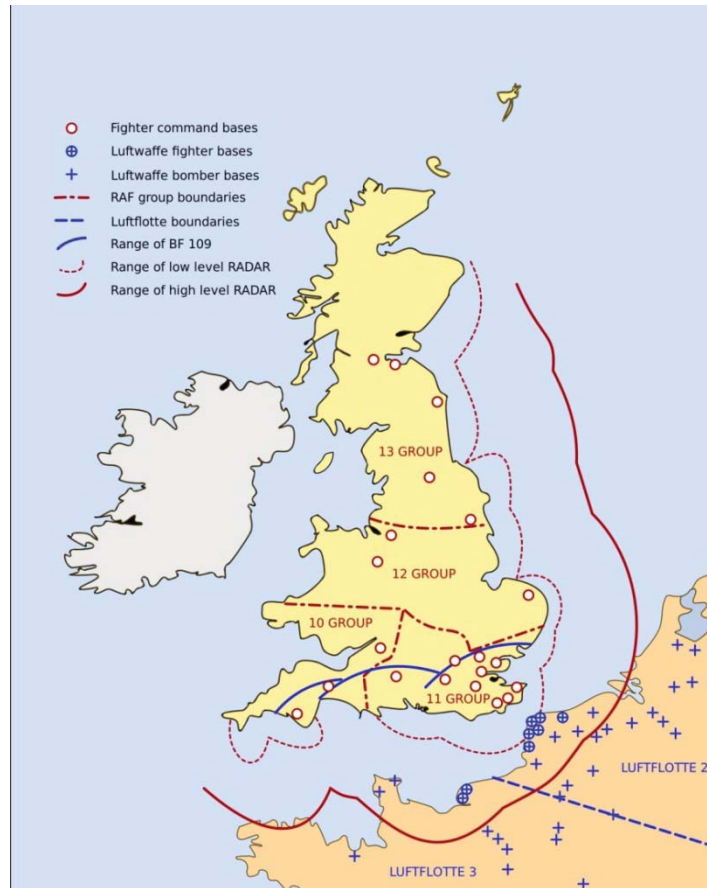

Source: Map from Wikipedia. See http://en.wikipedia.org/wiki/File:Battle_of_Britain_map.svg#filelinks

Figure A-1. Divisions of British Airspace by Group

Another key component of the C2 system's design was redundancy of the command centers and a robust capability to repair telephone lines (using dedicated telephone engineers) that were cut despite their initial hardening. Sector operations rooms used to control base activities also had a nearby backup facility available.

C2 Agility Summary: In order to achieve the overarching purpose of avoiding a ground invasion of Britain, the RAF devised a new operational approach for air defense. It also implemented a corresponding C2 approach to allow varying degrees of centralized control over its newly-created integrated air defense system. The C2 approach was evident in a variety of newly created C2 activities, including reports provided to the Operations Center from radar facilities, ground observers, and radio intercepts; as well as developing predictions about where the attacking Germans were going to strike and passing them to subordinate units. The C2 approach was also evident in the procedures used to determine which component of the air defense system would respond to an attack. C2 Agility enabled authority to be exercised as needed according to the circumstances, so that air controllers could vector aircraft towards incoming enemy aircraft, and then, when fighters were in visual contact, they could assume control of the engagement.

C. UNITAF (Unified Task Force) in Somalia

The events in October 1993 described in the book *Black Hawk Down* occurred during a United Nations (UN)-led operation in Somalia called United Nations Operations in Somalia II (UNOSOM II). Less well known are the manifestations of C2 Agility that occurred during the five-month UNITAF period that followed UNISOM I, before the UN again took over in May 1993.

For months during 1992, Somalia had been on a downward spiral due to the collapse of its government and fighting among its rival clans. Large segments of the population were facing starvation because the clans were using food as a weapon, preventing international relief organizations from distributing it where needed.⁵² Then on 4 December 1992, President George H. W. Bush announced the initiation of Operation Restore Hope. Under the terms of UN Security Council Resolution 794 (passed the previous day), the United States would both lead and provide military forces to a multinational coalition to be known as the Unified Task Force, or UNITAF. This force would create the security conditions necessary for a peacekeeping operation or until the situation stabilized enough

⁵² CENTCOM had been directing an airlift of relief supplies into the interior of Somalia since August 1992, but this did not solve the underlying problem or the clan stranglehold on Mogadishu.

for it to be turned over to a permanent UN peacekeeping force.⁵³ The U.S. portion of the mission, which lasted five months, fell to the Commander in Chief, U.S. Central Command (USCINCCENT.) The CENTCOM mission statement read:

When directed by the NCA, USCINCCENT will conduct joint/combined military operations in Somalia to secure the major air and sea ports, key installations and food distribution points, to provide open and free passage of relief supplies, provide security for convoys and relief organization operations, and assist UN/ NGOs [non-governmental organizations] in providing humanitarian relief under UN auspices.⁵⁴

Due to the geography, response times and ready capabilities, including an offshore Marine Expeditionary Unit (MEU), CENTCOM requested the First Marine Expeditionary Force (IMEF) from Camp Pendleton, California, to lead the U.S. forces in Somalia and provide a C2 structure for the international effort. CENTCOM was alerted to the possible mission about two weeks before the initial forces were scheduled to land on 9 December. IMEF had even less time to deploy its headquarters, the lead elements of which arrived shortly after the MEU had landed and secured the airport on the coast. When IMEF headquarters (HQ) deployed, it had only a rough idea of which U.S. forces would participate,⁵⁵ and it did not have a clear picture of the situation on the ground.⁵⁶ It did not even have a complete list of the countries that would comprise the coalition, nor their size and capabilities. Due to the time constraint, IMEF HQ deployed “as is.” As it engaged the various entities within the operational environment, it immediately began to demonstrate C2 Agility, adapting the initial C2 approach it brought with it to the realities on the ground.

Over the next few weeks, the IMEF HQ staff was augmented by other Service expertise and in some cases by coalition representatives. At a minimum all coalition members established liaison teams at IMEF HQ. These teams were often headed by a senior officer regardless of the size of the coalition member’s actual contribution. Soon after arriving, IMEF determined there was no requirement for its air wing HQ or for the Marine Corps-based joint force air component command (JFACC) that had deployed. Accordingly they were sent home. Early on, IMEF created a civil-military operations center (CMOC), headed by a colonel, within its operations directorate (CJ-3).⁵⁷ This center

⁵³ Kenneth Allard, *Somalia Operations: Lessons Learned*, CCRP Publication Series, 1995), 13.

⁵⁴ Allard, 13-14.

⁵⁵ Major headquarters were identified but size of each Service contribution was not yet decided, as it depended on the size and capabilities of coalition force contributions, which were not yet known as of 9 December 1992.

⁵⁶ Somalia was a low priority for U.S. intelligence organizations during the Cold War and its aftermath. For example, HUMINT (human intelligence) was virtually nonexistent and maps were 20 years out of date.

⁵⁷ Allard, 97-99.

was a critically important addition to the HQ, because its job was to ensure that NGOs had the security they needed to distribute relief supplies, the very essence of UNITAF's mission. At the time, the NGOs were fiercely independent and wary of letting it appear they were associated with, or agents of, UNITAF. The center's daily close coordination with NGOs was a challenge, but it was also an essential C2 activity. IMEF also created numerous liaison teams, some out-of-hide and some consisting of special operations forces (SOF)⁵⁸, to establish linkages with members of the coalition and other entities in Somalia, including most of the clans, as discussed below. Additionally, an Army psychological operations (PSYOP) unit ran a radio station and published a newspaper to ensure UNITAF intentions and actions were understood, the behaviors which would invite use of force under the UNITAF rules of engagement were clear, rumors were squelched, and daily developments were reported factually.

Externally, IMEF faced two C2 challenges. The first was to establish appropriate C2 arrangements among U.S. and coalition forces from more than 20 countries. C2 of U.S. forces was straightforward, because the Marines were assigned to UNITAF and the other U.S. forces were governed by established command relationships. However, many of the coalition forces were subject to restrictive national caveats. As a result, IMEF and UNITAF had to negotiate the missions to be assigned to these forces, which also required varying degrees of vetting through their national channels. These operational restrictions significantly impacted the flexibility and responsiveness of the force, and required a more flexible C2 approach. The UNITAF force structure and command relationships are shown in Figure A-2.

⁵⁸ Richard W. Stewart, *The U.S. Army in Somalia: 1992-1994*, Center for Military History Online Pub 70-81-1, 2003.

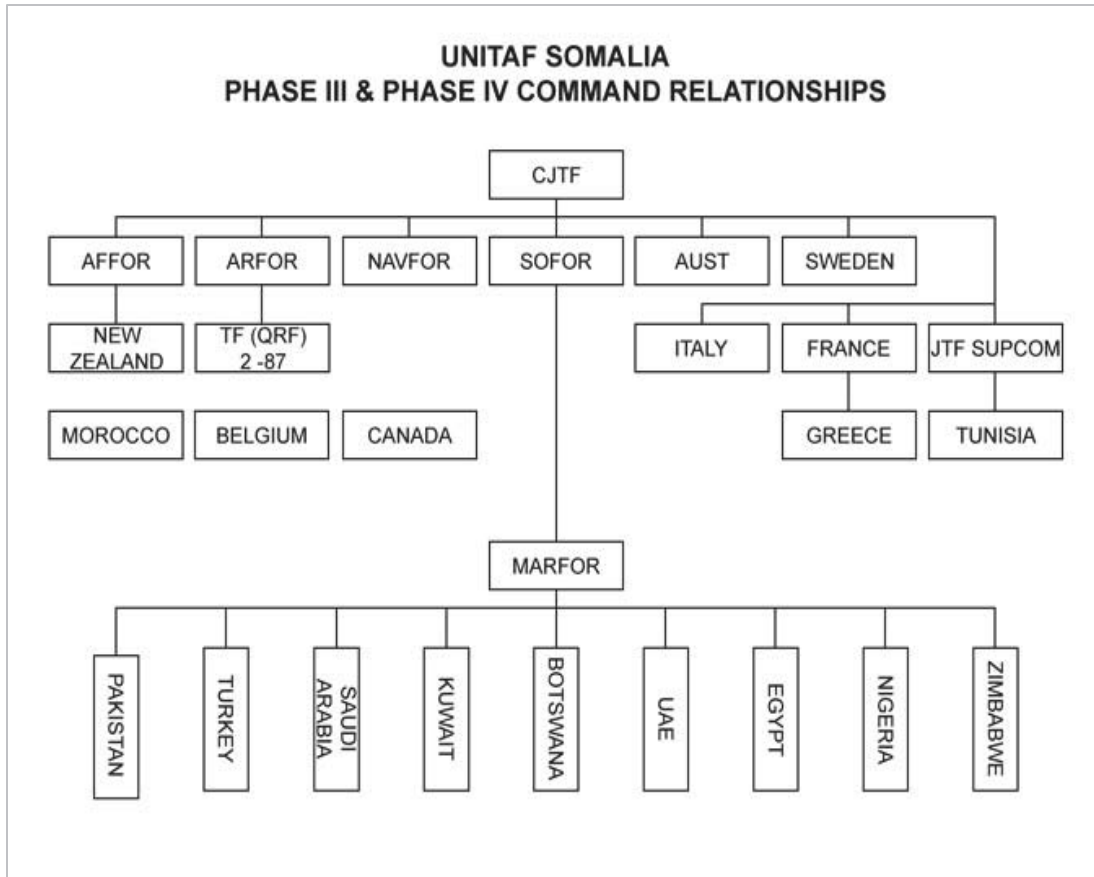

Figure A-2. UNITAF Force Structure

The second external UNITAF challenge was ensuring that all the other organizations and groups in the area of operations (roughly the southern third of the country) either supported what UNITAF was trying to accomplish or at least did not impede it. Since none of these entities were under UNITAF’s direct control, the effort relied upon a variety of C2 activities that a U.S.-only operation would not have had to consider. These activities included diplomacy, cajoling, extensive coordination, offers of security and logistic support, and, in some cases, direct threats and even application of force. Fortunately, Ambassador Robert B. Oakley was appointed as President Bush’s special envoy to Somalia at the beginning of the operation. Oakley, a former ambassador to Somalia, knew many of the key clan leaders and understood the internal dynamics of the country.⁵⁹ These attributes were crucially important in convincing the clans not to resist UNITAF’s efforts and to stand aside during UNITAF operations. Although Oakley was not part of IMEF, he fully supported its operations, as did other elements of the U.S. Government that were not under IMEF’s control. This was not C2 in the classic sense; rather, it was a continuous

⁵⁹ Due to illness he was later replaced by another Africa-experienced ambassador.

effort to forge a shared focus on the purpose of the endeavor at hand, and convergence on the ways and means of accomplishing it. Without this indirect C2 approach, and the focus and convergence it enabled, UNITAF could not have succeeded. Important external linkages were as shown in Figure A-3.

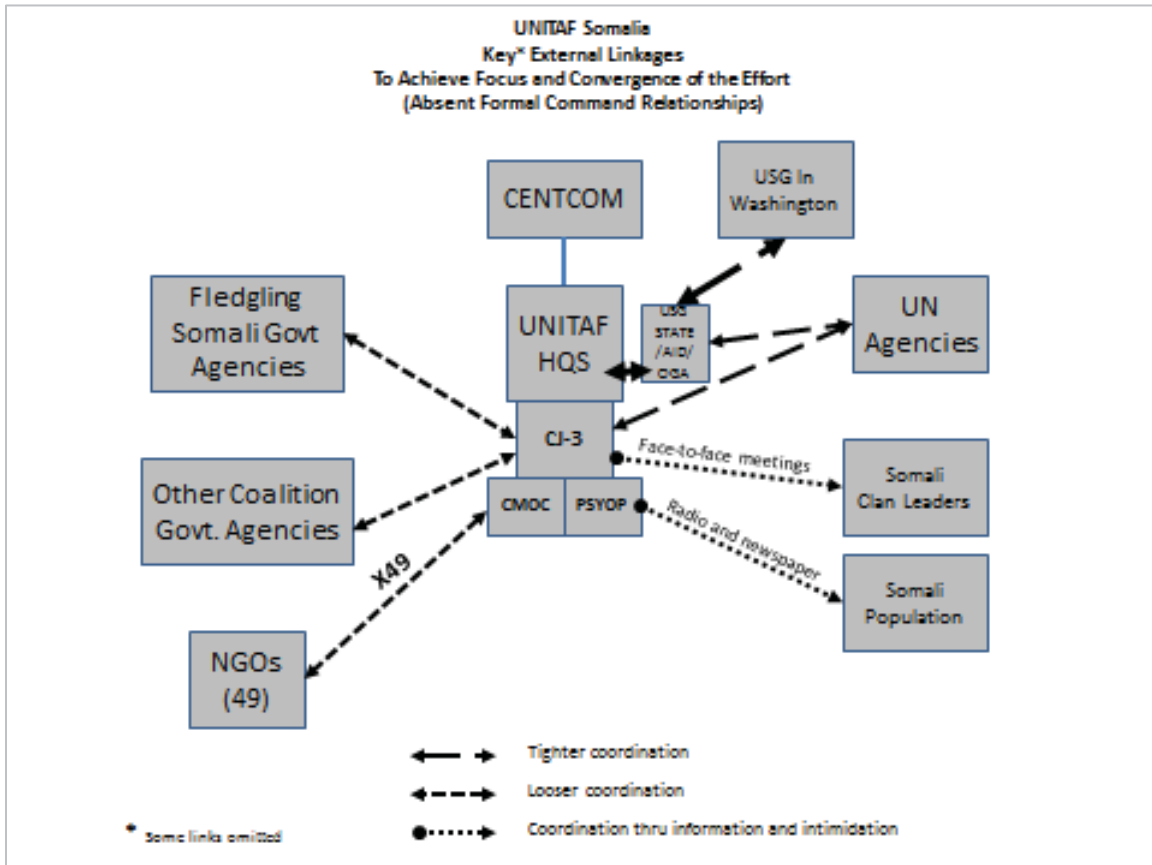

Figure A-3. UNITAF's External Linkages

C2 Agility Summary: By early January 1993, less than a month after entering Somalia from a cold start, IMEF/UNITAF had adapted its C2 approach to align it with its operational approach and the realities of its environment, mission, and organization. It had shed C2 structure that was not needed and created new structure that was needed. Further, it had incorporated coalition members of varying capabilities and had established relationships tailored to the entities involved (and to their various degrees of subordination). Upon recognizing the need to establish linkages (relationships) and, if possible, communities of interest, with all the relevant external actors, including the clans that were the underlying cause of the crisis, it established those links. This led to the beginnings of a shared understanding of what was to happen (providing focus) and the necessary cooperation of all actors needed to achieve the limited objectives (enabling convergence). In summary, despite an extremely austere and initially hostile environment, IMEF's C2 Agility yielded an effective UNITAF in a very short time.

D. Joint Special Operations Task Force in Iraq

As commander of Joint Special Operations Task Force (JSOTF) in Iraq, General Stanley McChrystal found that his existing command and control approach impeded his ability to implement a new concept of operations focused on fighting the enemy's network.⁶⁰ So he set about making his C2 approach more agile, as he described later:

But fashioning ourselves to counter our enemy's network was easier said than done, especially because it took time to learn what, exactly, made a network different. As we studied, experimented, and adjusted, it became apparent that an effective network involves much more than relaying data. A true network starts with robust communications connectivity, but also leverages physical and cultural proximity, shared purpose, established decision-making processes, personal relationships, and trust. Ultimately, a network is defined by how well it allows its members to see, decide, and effectively act. But transforming a traditional military structure into a truly flexible, empowered network is a difficult process.

Our first attempt at a network was to physically create one. We convinced the agencies partnered with the JSOTF to join us in a big tent at one of our bases so that we could share and process the intelligence in one location. Operators and analysts from multiple units and agencies sat side by side as we sought to fuse our intelligence and operations efforts—and our cultures—into a unified effort. This may seem obvious, but at the time it

⁶⁰ Stanley A. McChrystal, "Becoming the Enemy," *Foreign Policy* 185 (2011): 66-70.

wasn't. Too often, intelligence would travel up the chain in organizational silos—and return too slowly for those in the fight to take critical action.

It was clear, though, that in this fusion process we had created only a partial network: Each agency or operation had a representative in the tent, but that was not enough. The network needed to expand to include everyone relevant who was operating within the battlespace.

Incomplete or unconnected networks can give the illusion of effectiveness, but are like finely crafted gears whose movement drives no other gears.

This insight allowed us to move closer to building a true network by connecting everyone who had a role—no matter how small, geographically dispersed, or organizationally diverse they might have been—in a successful counterterrorism operation. We called it, in our shorthand, F3EA: find, fix, finish, exploit, and analyze. The idea was to combine analysts who found the enemy (through intelligence, surveillance, and reconnaissance); drone operators who fixed the target; combat teams who finished the target by capturing or killing him; specialists who exploited the intelligence the raid yielded, such as cell phones, maps, and detainees; and the intelligence analysts who turned this raw information into usable knowledge. By doing this, we speeded up the cycle for a counterterrorism operation, gleaning valuable insights in hours, not days.

But it took a while to get there. The process started as a linear, relatively inefficient chain. Out of habit (and ignorance), each element gave the next group the minimum amount of information needed for it to be able to complete its task. Lacking sufficient shared purpose or situational awareness, each component contributed far less to the outcome than it could or should have.

This made us, in retrospect, painfully slow and uninformed. The linear process created what we called “blinks”—time delays and missed junctures where information was lost or slowed when filtered down the line. In the early days of the effort, we had multiple experiences where information we captured could not be exploited, analyzed, or reacted to quickly enough—giving enemy targets time to flee. A blink often meant a missed opportunity in an unforgiving fight.

The key was to reduce the blinks, and we did so by attempting to create a shared consciousness between each level of the counterterrorism teams.

We started by sharing information: Video streamed by the drones was sent to all the participants—not just the reconnaissance and surveillance analysts controlling them. When an operation was set in motion, information was continuously communicated to and from the combat team, so that intelligence specialists miles away could alert the team on the ground about what they could expect to find of value at the scene and where it might be. Intelligence recovered on the spot was instantly pushed digitally from the target to analysts who could translate it into actionable data while the

operators would still be clearing rooms and returning fire. This knowledge was immediately cycled back through the loop to our intelligence and surveillance forces following the results of the raid in real time.

The intelligence recovered on one target in, say, Mosul, might allow for another target to be found, fixed upon, and finished in Baghdad, or even Afghanistan. Sometimes, finding just one initial target could lead to remarkable results: The network sometimes completed this cycle three times in a single night in locations hundreds of miles apart—all from the results of the first operation. As our operations in Iraq and Afghanistan intensified, the number of operations conducted each day increased tenfold, and both our precision and success rate also rose dramatically.

This example vividly illustrates the importance of adapting command and control approaches to the circumstances of the environment, organization, and the mission—the object of C2 Agility as presented in this handbook. Although the improved C2 approach General McChrystal describes was developed without prior exposure to the concept of C2 Agility, it nevertheless illustrates the richness of the concept and its potential value in guiding future assessments and adjustments to C2 practices.

C2 Agility Summary: General McChrystal realized he needed a new operational approach in order to defeat the enemy’s network. His description of the changes to his C2 approach illustrates the importance of thinking about C2 in a systematic way. This is because changes in one dimension often create the need to change in another dimension. In essence *decentralization* was needed to accelerate the pace of operations. But to achieve decentralization, *collaboration* needed to improve and *information flows* needed to accelerate. This example also illustrates how the activities associated with a C2 approach can morph and grow, one step often leading to another. For example, the linkages among all parties were at first linear, resulting in gaps or “blinks” in shared awareness. Over time it became clear that merely establishing linkages was not sufficient, if the amount of information passed along the links was minimized. It was only by changing their activities—in this case, by widely sharing the drone video—that shared awareness started to develop, which in turn led to even more intelligence sharing with combat teams. Further, by continually assessing the results—and measuring how the increased C2 activity led to increases in operational tempo, precision and success—the JSOTF could definitively conclude that it was on the right track.

E. Unity of Effort in Security Force Assistance Operations⁶¹

After nearly a decade of war in Afghanistan and following the surge of U.S. forces in 2010- 2011, the U.S. Army assessed that a larger combat advisory effort to Afghan National Security Forces (ANSF)—comprised of the Afghan National Army (ANA), Afghan Border Police (ABP) and Afghan Uniform Police (AUP)—was required to sustain the security gains of the surge. Combat advisors with the ANSF would allow the International Security Assistance Force (ISAF) to continue to assist in the maturation of the ANSF, as the drawdown of coalition forces began in 2012 and progressed towards a minimal international presence by the end of 2014.

The Army took lessons learned from previous combat advisory efforts in Iraq and Afghanistan by Military Transition Teams (MiTTs), and built the Security Forces Advise and Assist Team (SFAAT) program to conduct this advisory effort in Afghanistan. Each team was led by a Major or Lieutenant Colonel and Master Sergeant or Sergeant Major, and had ten other officers and non-commissioned officers with skills in combat arms, intelligence, fire support, and logistics. SFAATs were formed from across the Army at Fort Polk, LA and received specialized combat advisor training prior to deploying to Afghanistan. Some SFAATs deployed directly into Afghanistan from Fort Polk, while others joined deploying Brigade Combat Teams (BCTs) as part of their organization. Five SFAATs would deploy in this manner with the 3rd BCT, 101st Airborne Division.

In the months prior to the 3rd BCT's deployment to Afghanistan, the brigade's commander, Colonel (COL) RJ Lillibridge, and his senior staff wrestled with the C2 approach needed for this complex operation. Specifically, they sought to identify appropriate command relationships among their headquarters and the many other organizations present in their future area of operations (AO) in eastern Afghanistan, including Provincial Reconstruction Teams (PRTs), the United States Agency for International Development (USAID), other government agencies (OGAs), and the Commander, Joint Special Operations Task Force (CJSOTF). Despite some muddled and non-standard relationships with these organizations, all had been operating in Afghanistan for years and had established relationships and coordination methods with the brigade that the 3rd BCT would replace.

The SFAATs would be the only new entity in the AO. Integrating these teams carried even higher stakes than did working with the organizations already operating in the 3rd BCT's area because transferring responsibility for Afghan security to local authorities was

⁶¹ Colonel (COL) R. J. Lillibridge, U.S. Army, provided the basis for this vignette while serving as the Chief of Staff of the Army Senior Fellow at the Institute for Defense Analyses in 2013-2014.

the coalition's primary purpose.⁶² Thus it was vital for the BCT to make every effort to ensure their success.

The 3rd BCT would deploy with the five internal SFAATs mentioned above, but would also be responsible for the efforts of 16 additional SFAATs from across the active Army, Army National Guard, and Army Reserve that would be in the AO. Some would arrive in Afghanistan prior to the BCT, some after. More importantly, when 3rd BCT leaders visited Afghanistan four months before deployment, they found that the ANSF units they were to partner with lacked the competence and confidence to lead unilateral Afghan operations. As a result, the BCT's planned C2 activities, which assumed Afghan forces would be operating on their own, would have to change. SFAATs alone could not remedy these shortcomings.

BCT leaders recognized that their organic infantry rifle companies and reconnaissance troops were fully trained and were mentally prepared to conduct partnered operations in order to increase the ANSF's collective competence and confidence at the tactical level. But these companies and troops had neither the rank nor experience to advise Afghan battalion-level formations, which are commanded by Afghan Lieutenant Colonels and Colonels. SFAATs were intended to fill this organizational gap. But two previous deployments with MiTTs in Iraq had shown COL Lillibridge that without clearly delineated roles, responsibilities, and command relationships between battlespace-owning units (in this case the BCT's companies and troops) and combat advisors, well-intentioned MiTT officers and NCOs often found themselves working at cross-purposes, thus losing credibility with their Iraqi partners. He was determined to not repeat this error.

As the commander and staff dug into the Regional Command-East (RC-E) orders and directives, they could find no clear articulation or intent outlining the relationships or authorities between Army formations assigned responsibility for security and other missions in an assigned area of operations (i.e., the 'battlespace owners') and SFAATs. They queried the SFAAT academy at Fort Polk for ideas, to no avail. The problem they were trying to resolve is depicted by the battlefield geometry shown in Figure A-4.

⁶² Marine Corps Gen Joseph F. Dunford Jr., ISAF commander, articulated this overarching purpose in a speech to the Reserve Officers Association in August 2013. "Winning means setting the conditions for the Afghans to exploit opportunities while developing the Afghan forces and sustaining them," Dunford told the audience. This can be done, he added. "It is by no means inevitable, but it is achievable," Dunford said. Jim Garamone, "ISAF Chief Briefs Reservists on Afghan Progress, Future," U.S. Department of Defense, American Forces Press Service, August 8, 2013. <http://www.defense.gov/News/newsarticle.aspx?ID=120598>.

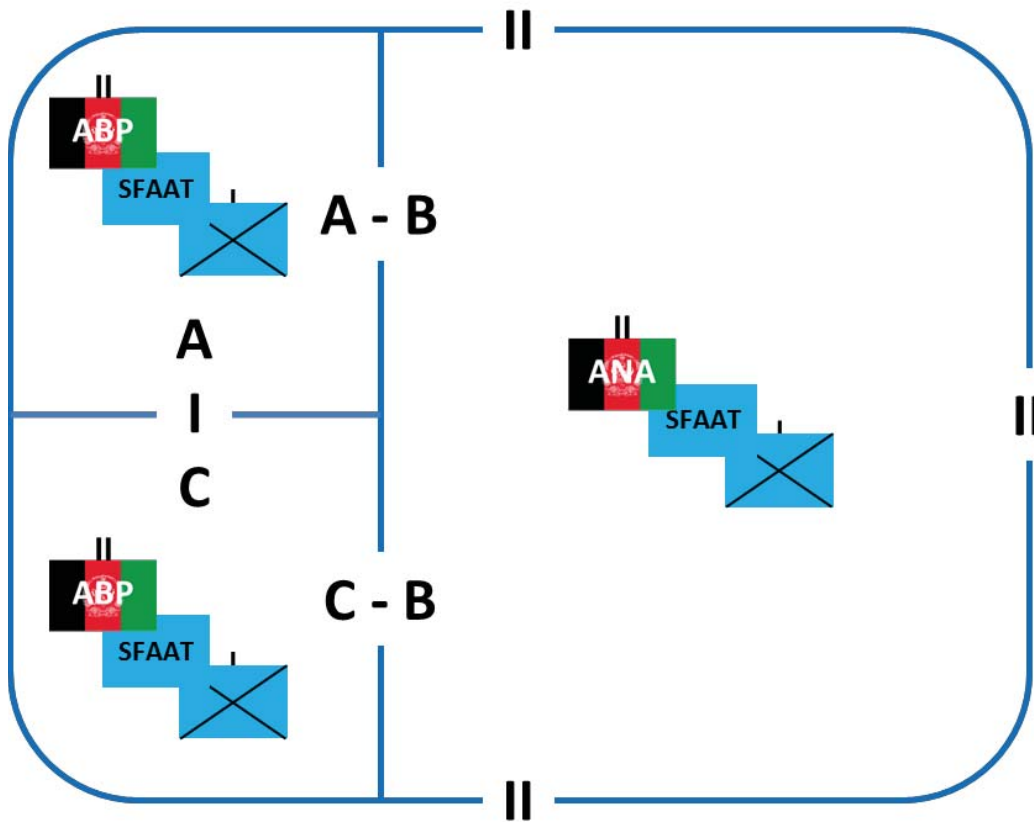

Figure A-4. Battalion-level Battlespace Geometry

The battalion commander ‘owned’ the battlespace within the outer border (depicted by the “II” symbols). In this example, that meant he was responsible for the actions of the battalion’s three companies, plus two ABP battalions and an ANA battalion. The three companies (depicted by “I” symbols and the letters A, B, and C respectively) were each responsible for an area of operation (AO) within the battalion’s battlespace (the smaller areas outlined in blue), in concert with their partnered ABP or ANA battalion. But the SFAAT teams, led by field grade officers and senior non-commissioned officers, would be collocated with those companies, and their leaders would outrank the companies’ senior leaders. This had created friction in COL Lillibridge’s two previous deployments to Iraq, when combat advisors attempted to take command of collocated companies and troops, or had worked at cross-purposes to the battlespace-owning battalion commander.

BCT leaders finally resolved that a defined command relationship among all parties was less important than achieving unity of effort by concentrating on ISAF's purpose. With this new focus upon assuring unity of effort, they established the following roles and responsibilities to guide the activities of the involved parties:

- Battalion Commanders (“11”) were the battlespace owners, responsible for all U.S. and Afghan actions and activities in their AOs. These commanders would encourage the ANSF commanders in their battlespace to work in support of one another, or, at the very least, not to work at cross-purposes.
- SFAATs were responsible for advising and assisting their respective ANSF headquarters and staff, in accordance with COL Lillibridge's—and more importantly, the battlespace-owning battalion commander's—guidance and intent. SFAATs were prohibited from participating in combat operations unless their Afghan battalion commander personally went on the operation. This was a significant deviation from the role of MiTTs in Iraq and Afghanistan, where the MiTT had been required to participate in all combat operations as the MiTT was the only conduit to coalition combat enablers, such as reconnaissance, fires, and medical evacuation.

Rifle Companies and Reconnaissance Troops were responsible for partnered combat operations with their collocated ANSF units and the application of any coalition combat enablers. These companies and their ANSF partners would conduct the operations planned by the ANSF HQs and SFAATs. But these companies and troops took their orders from their battalion commander, not the SFAAT.

In order to assure all involved understood COL Lillibridge's intent, the BCT published this guidance in a Terms of Reference prior to deploying, and COL Lillibridge personally briefed every SFAAT already operating in the brigade's AO when the 3rd BCT arrived in Afghanistan. In addition, each SFAAT that arrived after September 2012 spent a day at the BCT headquarters, receiving orientations on the AO and personally hearing COL Lillibridge describe the roles and responsibilities he had established. Commanders of the 3rd BCT's battalions and companies all reinforced these points every day as they circulated within the battlefield.

According to COL Lillibridge, the end result was an outstanding unity of effort by all involved in the AO. Issues rarely arose between commanders and SFAATs. More importantly, U.S. forces never found themselves at cross-purposes with one another or with their Afghan partners, even as they successfully transferred a larger portion of security responsibilities to the Afghans every month. As the ISAF commander stated in August 2013, “If the trajectory that we've been on for the past couple of years continues

for the next 16 months, I am very comfortable about where we will be with the Afghan forces.”⁶³

C2 Agility Summary: In order to enable ground forces to build the capacity and capability of Iraqi and Afghan security forces, the Army created new types of units, the MiTTs and SFATTs, but the operational approach and C2 approach were not changed commensurately. This led to the friction COL Lillibridge had experienced in Iraq, where the lack of clarity on how to interact with battlespace owners, coupled with the seniority of the MiTT leadership, led them to exert authorities that were at cross-purposes with other units. Therefore, the BCT devised an operational approach that maximized interaction between SFATTs and the ANSF, while enabling the BCT to take the lead for all other operational tasks and to participate in all combat operations. The new C2 approach was tailored to support this operational approach in several key respects. First, it assigned authority to the battlespace owners for all missions, and gave them control over enablers provided by the coalition. Second, it restricted the authority of the SFATTs, thereby removing conflict over who was in charge between them and the battlespace owners. Lastly, the C2 activities continually reinforced and supported the C2 approach; for example, by commanders reiterating the ground rules as they circulated around the battlefield, and SFATTs participating in operations only when their Afghan partner was present.

F. Brigade Counterinsurgency Assault, 2005⁶⁴

In October 2005, the U.S.-led coalition faced a stubbornly persistent insurgency in Anbar Province, Iraq. The province accounted for 20 percent of U.S. troops but 40 percent of U.S. casualties.⁶⁵

U.S. forces were approaching a strategic inflection point, in which they would shift from counter-insurgency efforts toward a more population-centric stability operation. Against this backdrop, the 2nd Marine Division’s Regimental Combat Team 2 (RCT 2) planned Operation River Gate, which was aimed at retaking three cities in Anbar Province that were under the control of insurgents that included Ansar al Sunna and Al Qaeda. As part of the operation, Task Force 3-504 (TF 3-504) of the 82nd Airborne Division was attached to RCT 2 and assigned the mission of seizing the town of Haqlaniya. With a

⁶³ Garamone, “ISAF Chief Briefs Reservists”

⁶⁴ This vignette is based on working papers provided by COL Larry Swift, U.S. Army. In 2004-2005, COL Swift served in Iraq as Commander, 3rd Battalion, 504th Parachute Infantry Regiment.

⁶⁵ West, *The Strongest Tribe*.

population of 15,000, Haqlaniya was essentially an insurgent sanctuary with no coalition presence following the departure of Iraqi forces in August 2005. The TF 3-504 Commander's intent was to focus on the enemy, break patterns set by previous units, and achieve surprise by conducting a decentralized attack against specific insurgent cell leaders, using detailed intelligence provided by displaced persons recruited from Mosul.

Initially, the task force commander envisioned a multi-axis, nearly simultaneous infiltration which would require tight control and precise timing. During this phase, centralized control was needed to safely move four companies of airborne infantry into assault positions around the target. Associated activities included a coordinated truck- and foot-infiltration from the south, a company air assault to the north, establishment of blocking positions on all approaches, pre-assault fires, and electronic attack.

However, once the assault phase began, both the operational approach and the C2 approach needed to change significantly. Retaining tight control would have dictated a linear, block-by-block clearance operation, requiring a central control node to keep track of and issue directions to a swarm of platoons and squads. Moreover, such a linear operation would have forfeited the advantage of surprise, thereby allowing the enemy to escape. Therefore, the commander chose to shift to a C2 approach consistent with the tenets of mission command—command by intent with decentralized execution. In so doing, he enabled TF 3-504 elements to maintain momentum and to maneuver in a nonlinear, and therefore less predictable, fashion.

Using this second operational approach, the three assaulting companies established platoon release points as they moved out of their assault positions, breaking each company apart into platoon formations. Upon entering the city, the platoons further broke apart into squads. Under the cover of darkness in an unfamiliar city, the squads exploited detailed intelligence, GPS technology, and superb non-commissioned officer leadership to move independently to some 30 separate locations and kill or capture enemy insurgents. Recognizing that some of the targets would move to other locations in the city, the C2 approach was altered to permit squads to conduct the initial assault and tactical site exploitation (to include tactical questioning) without seeking higher-level direction. Furthermore, if squads gained actionable intelligence on insurgent locations, they had the authority to immediately move to and assault the follow-on targets. The squads were given common graphics which included company boundaries and a city-wide system of building numbers, thereby enabling them to maintain shared situational awareness as they moved through the city. Platoon leaders and company commanders worked to shift enablers such as Explosive Ordnance Disposal, Human Intelligence teams, Point of Capture teams, helicopters, close air support, and quick reaction forces; and to track squads as they pursued the enemy wherever the intelligence took them. De-confliction of direct fires was achieved through a prior agreement to fire on identified targets only, and by shifting company boundaries as the squads attacked follow-on targets. The battalion intelligence

officer tracked changes in the enemy situation as the operation progressed by closely watching the “kill list.” In addition, he updated the enemy network template based on the results of each raid’s detainees and tactical questioning.

The intelligence-driven maneuver continued for 36 hours, yielding five insurgents killed in action, 120 insurgents and foreign fighters captured, and a covert medical facility neutralized. The operation also led to the discovery of vehicle-borne improvised explosive devices (VBIEDs) and a VBIED factory, enemy computers and electronic media, and documents including those of Al Qaeda leader Abu Musab al Zarqawi’s propaganda chief. Intercepted enemy communications indicated that the remaining insurgents were trapped and unable to move and were requesting assistance as a result of the continuous and unpredictable movements of “crack U.S. troops.”

C2 Agility Summary: The mission success of TF 3-504 was the result of the two differing operational approaches, and supporting C2 approaches, that were chosen, effectively leveraging the aggressive actions and initiative of U.S. airborne infantry. Successfully transitioning from an assault operation based on companies to a distributed operation conducted by squads required a major change in the C2 approach at a critical juncture. Prior planning enabled the task force to transition from a tightly controlled C2 approach to one that allowed for decentralized decision-making and initiative. As authority was pushed down to the squad level, higher-level commanders retained authority over critical resources that could be directed to specific squads as needed. In addition, information (graphics and building numbers) was widely distributed, and flexible means were developed for adjusting decision rights, including pre-arranged firing rules and moveable boundaries between units, that helped prevent friendly-fire incidents. As a result, U.S. forces maintained a rapid operating tempo, achieving decisive outcomes while preventing the insurgents from exercising initiative.

G. The Battle of the Frontiers, 1914

The German invasion of France and Belgium in 1914 is widely regarded as a failure. Although many explanations have been proffered for Germany’s lack of success in its bid to quickly defeat French forces during the Battle of the Frontiers, it is only recently that the German C2 approach and activities have been more closely examined. The analysis below is drawn from a 2005 article that summarized the findings of a “Logistics in War” seminar held at the Georgia Institute of Technology’s Sam

Nunn School of International Affairs.⁶⁶ The seminar's findings strongly suggest that the German forces' C2 approach and activities were inappropriate for the circumstances prevailing at the time of the battle, thus creating the conditions for defeat.

The German offensive employed a modified version of the Schlieffen Plan, with a right wing advancing through Belgium into France and a left wing giving ground to draw the French right flank into western Germany, where the German right wing would envelop them (Figure A-5).

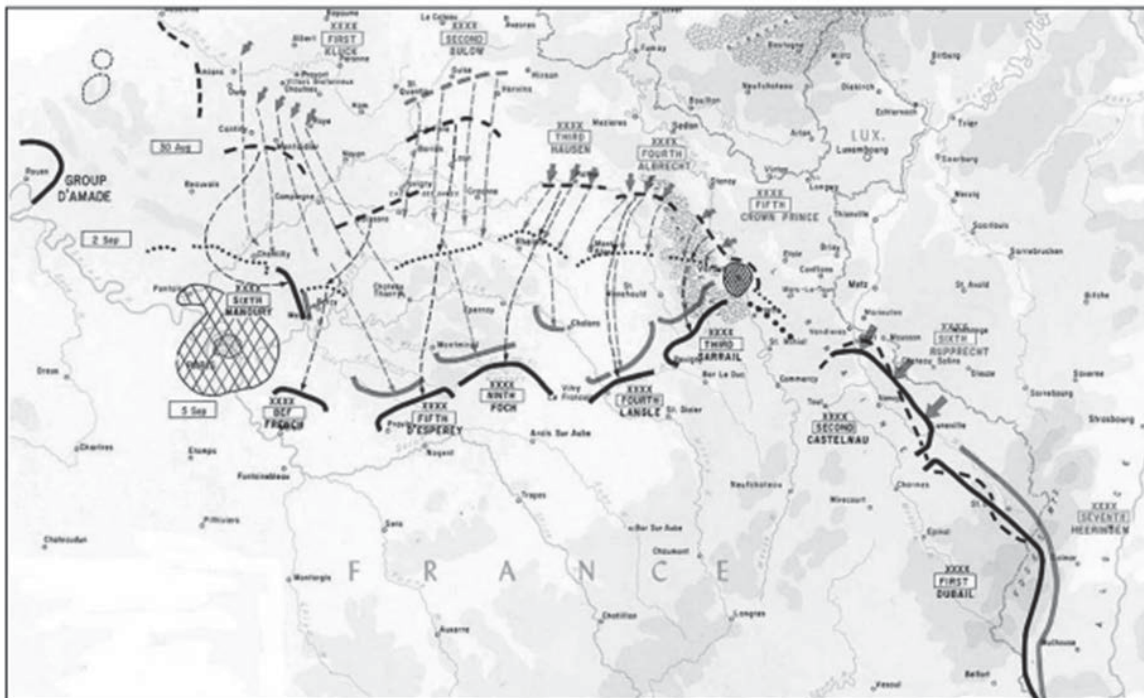

Figure A-5. The German Offensive, 30 August - 5 September⁶⁷

Several changes made by Chief of General Staff Helmuth von Moltke, the Younger, weakened the right wing and increased German resistance to an expected French assault on the left. These changes led to a situation in which the French were less likely to be drawn sufficiently far to the west to create a vulnerability that German forces could exploit. It also “created the conditions that led the Germans to believe, once the fighting started, that they could mount a successful counter-offensive” with the left wing.⁶⁸ Such a counter-

⁶⁶ Matthew Fuhrmann, Nathan Edwards and Michael Salomone. “The German offensive of 1914: A new perspective,” *Defense & Security Analysis*, 21:1 (2005), 37-66.

⁶⁷ Fuhrmann et al., 44.

⁶⁸ Fuhrmann et al., 40.

offensive, if successful, could have led to a double envelopment of French forces and a decisive victory for Germany. But by compressing French forces instead of drawing them westward, the left wing's counter-offensive placed at risk the success of the right wing—and with it that of the entire invasion.

An inappropriate C2 approach exacerbated these operational difficulties. The Germans chose to maintain the approach to command and control that they had successfully employed in the Franco-Prussian War in 1870. It featured mission type orders (*Auftragstaktik*) and afforded field commanders maximum latitude to make the decisions they thought best as their circumstances changed. However, this approach gave commanders no doctrinal means of accomplishing certain C2 activities, such as crossing organizational seams to obtain information, either from higher headquarters or from one another, about the situation of other German armies. Given that the size of the battlefield was much greater than that of the Franco-Prussian War, with German armies spread over hundreds of miles, this limitation was particularly acute. Although information could be shared voluntarily and supporting actions advised on an *ad hoc* basis, there was no one decision-maker who had full situational awareness. Further, information about deviations from the original plan was neither fully vetted nor widely shared. As discussed above, although it was allowed by Von Moltke, Crown Prince Rupprecht's decision to attack with the left wing was particularly consequential for Germany, in that it “abandoned the essence of their war plan.”⁶⁹

In addition to the German failure to systematically share vital information among field armies, many preplanned C2 activities actually contributed to a lack of situational awareness across the force. These activities were designed to support the chosen C2 approach of mission type orders, but they were not supportive of other approaches. For example, each army could communicate internally using balloons, motorcycles, and short-range radios; however, these activities could not be rearranged to foster communication across armies, particularly in hostile territory. In addition, communications jamming by the French coupled with complex codes led to long delays in the receipt of messages. These environmental conditions could have been foreseen and overcome by devising work-around operating procedures, but could not be corrected in the heat of combat. A solid operational design process could have anticipated these circumstances, recognized they were exacerbated by the size of the battle being contemplated, and provided a more resilient communications system and processes.

⁶⁹ Fuhrmann et al., 41-42.

C2 Agility Summary: A C2 approach optimized for mission-type orders given to each army was insufficient to support the operational approach that evolved, which required close coordination. And, lacking a C2 assessment process, German forces were unable to recognize this shortcoming in advance, or to adapt their C2 approach to the conditions they encountered.⁷⁰ Through careful analysis of the C2 implications of the Schlieffen Plan, they might have identified the desired information flows across armies, the expected collaboration between adjacent units, and the need for decision rights to be assigned to an echelon with adequate situational awareness. This would have led them to select a different C2 approach. Then, they could have noted, perhaps in an exercise, that their activities did not match the approach; for example, because one unit's alterations to a planned maneuver were not communicated to other units, or because decisions were not reached in a timely manner. In addition, since the approach required changes to communications linkages among German army headquarters and armies, it would have been reasonable to assess whether those linkages were in place and effective.

The above analysis points to the need to ensure C2 Agility in advance of an operation. This is because mistakes will certainly be made, unexpected events will occur, and circumstances will change. One of the most quoted axioms along these lines, that "no plan survives first contact with the enemy," is attributed to von Moltke, the Elder (1800-1891), who was the uncle of the senior German commander in this battle. Given this insight, it is reasonable to assess whether the German headquarters and field commanders were sufficiently agile in the face of change. Collective agility was required because the situation was complex and thus could not be decomposed into independent parts. In fact, individual agility in the absence of shared awareness was a cause of the ultimate German failure in the Battle of the Frontiers.

H. Joint Special Operations Air Component – Haiti⁷¹

Port-au-Prince, Haiti. 12 January 2010, 4:53 PM: A 7.0-magnitude earthquake struck and killed 220,000, injured over 300,000, and destroyed 54 percent of the buildings in a city housing over a quarter of the nation's populace.⁷² In response, the United States

⁷⁰ Fuhrmann et al., 55.

⁷¹ Lieutenant Colonel Travis Norton, USAF, provided this vignette while serving as the Air Force Executive Fellow at the Institute for Defense Analyses in 2014-2015.

⁷² United States Census Bureau, "Census Data & Emergency Preparedness, Earthquake in Haiti," https://www.census.gov/newsroom/emergencies/earthquake_in_haiti.html (Accessed, 11 Aug 14). Death toll numbers from Lt Gen (ret) Glenn Spears, "Command & Control Agility during Disaster Response," undated Power Point presentation.

Agency for International Development (USAID) was tasked to lead an international response effort, supported by military capabilities from the Department of Defense. Within 24 hours, Air Commandoes from the 1st Special Operations Group (SOG), led by Colonel (Col) “Buck” Elton, deployed to establish the Joint Special Operations Air Component-Haiti (JSOAC-H). Within 28 minutes of their arrival, Col Elton’s team established command and control (C2) of the airfield and began operations to support the influx of humanitarian supplies from at least 140 countries and more than 1,000 non-governmental organizations.⁷³ At an airfield that typically saw on average just 3 aircraft each day, JSOAC-H facilitated over 200 aircraft per day, totaling 1,667 aircraft arrivals, 800 rotary-wing missions, and the delivery of four million pounds of food and supplies, to include 80,000 pounds air dropped to areas that otherwise could not be reached.⁷⁴ The following vignette highlights how Col Elton’s team assessed their mission, their command’s organic capabilities, and the operational environment; applied the principles of C2 Agility; and adapted their C2 approach to enable successful international relief efforts to a devastated nation.

On the day the earthquake struck, the 1st SOG had just concluded a seven-day Operational Readiness Exercise, during which they rehearsed self-deploying to, and organically sustaining operations at, an austere base.⁷⁵ Upon seeing the news about the earthquake, Col Elton directed “don’t unpack,” immediately returning the group to its exercised alert posture, restocking supplies where necessary. Conveniently stationed in close proximity to Haiti and “unusually prepared” due to the just-completed exercise, Col Elton notified his superiors that his group was postured for an immediate response. Unfortunately this advanced state of readiness was not matched by the interagency enterprise’s ability to respond in kind. The chaotic situation within Haiti left too many questions unanswered for planners. What forces were available? What were the requirements? How large a force was required? How should they be task-organized? Simply put, no one could write the orders fast enough while the 1st SOG sat ready to deploy. Anticipating this challenge, 1st SOG planners prepared a draft deployment order, which task-organized them in the exact manner they had just rehearsed. Passing this draft order up the chain, Col Elton sought verbal orders to deploy immediately without having to

⁷³ Senior Airman David Salantri, Air Force Special Operations Command Public Affairs, “AFSOC Airmen save Haitian earthquake victim, land more than 600 aircraft on island,” *Air Force Times*, 1/17/2010, accessed 25 July 2014. <http://www.afsoc.af.mil/news/story.asp?id=123186022>. Country and NGO totals came from Lt Gen Spears’ brief.

⁷⁴ “Unified Response: JSOAC-Haiti,” undated Power Point presentation used by USAF Special Operations School, given to author by Brig Gen Elton via email on 25 July 2014.

⁷⁵ Brig Gen Albert “Buck” Elton (Joint Special Operations Command), interview by the Author, 25 July 2014. All subsequent information throughout this vignette concerning JSOAC-Haiti operations and 1st SOG came from this interview. Subsequent end-note references are not provided.

wait for official message traffic to catch up. Approximately 13 hours after the earthquake, he was directed to deploy.

Anticipating some C2 ambiguity, Elton sought senior commanders' intent and received the following,

Go do good things. Let me know what you need.
- Lt Gen Wurster, AFSOC/CC
Fill the void. Be value added. Be Aggressive
- Brig Gen Pagan, SOCSOUTH/CC

Capitalizing on the flexibility provided, Col Elton provided this open guidance to his team:

“Assume you have the authority to do the right thing”

This level of autonomy proved crucial to the successful employment of the 1st SOG during its initial response. Upon their departure, members of the 1st SOG were already organized and prepared to operate as close to the broad and unconstrained C2 approach as possible, allowing them the freedom of action to “go do good things” (Figure A-6).⁷⁶ Though limited by an improvised and immature information distribution network

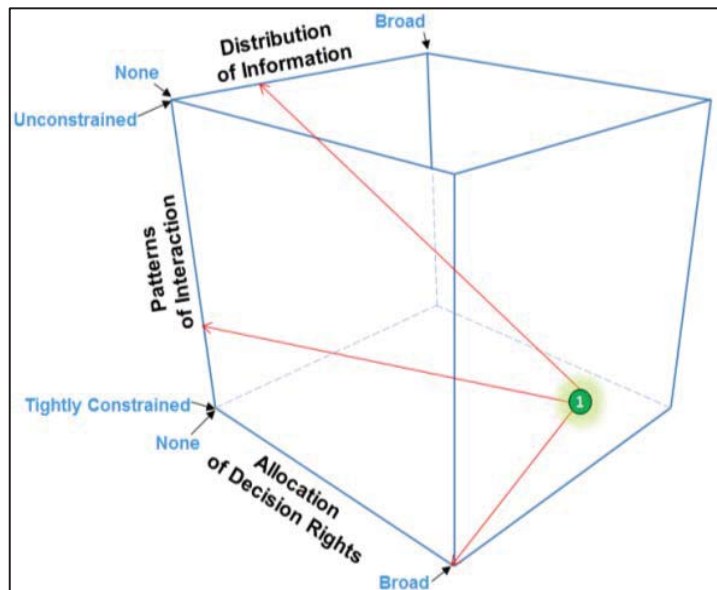

Figure A-6. C2 Approach Space, upon Initial Deployment

and not yet fully integrated with the interagency/international team in charge (much of which was still en route), Col Elton was empowered by his chain of command, and subsequently empowered his subordinate leaders with the absolute authority to make their own decisions

⁷⁶ C2 Approach Space graphic is a visual depiction of the NATO's Networked Enabled Capability C2 Maturity Model. The model is described in detail in NATO NEC C2 Maturity Model, (Washington D.C., CCRP, 2010), 43-71. Accessible at the CCRP Publications website, http://www.dodccrp.org/html4/books_main.html.

based on commander’s intent. The command team and subordinate unit communications processes were already adjusted based upon lessons learned from the just-completed exercise. While decision authority was delegated down and across the chain of command, Col Elton retained overall command authority and used basic methods to convey his intent. This well-integrated team knew they could control organic operations. They now looked to how they could enable success by integrating and establishing the necessary linkages/relationships required within an *ad hoc* international relief effort.

Arriving in the early evening a day after the quake, Combat Controllers from the 23rd Special Tactics Squadron began operating within 28 minutes of their arrival from a makeshift ‘control tower’ on the infield of the airfield, using a simple hand-held radio and a stool. Col Elton understood that although Haiti had asked for international assistance, it was a sovereign nation and he did not ‘own’ the airfield. However, assessing that no one was able, or even attempting, to fill the role of Senior Airfield Authority, Col Elton simply took charge. As he later stated, he didn’t necessarily have the authority or guidance to do so, but the airfield needed a single authority to coordinate operations, and his team had the capacity and experience to do so. Though he took on this responsibility, Elton understood his Group was a small piece of the much larger international effort. Therefore, he sought out and introduced himself to the USAID mission director by simply stating, “I work for you. What do you need?”

Accustomed to the stereotype of military officers trying to take control, the surprised USAID official eagerly shared the regional understanding that would be essential to enabling the Haitian government to distribute relief supplies as they arrived. Building upon his lessons-learned networks, built during counter-terrorism operations, Elton quickly dispatched Liaison Officers (LNOs) to integrate within USAID, the myriad government (U.S. and Haitian) entities, and the extensive number of non-governmental relief

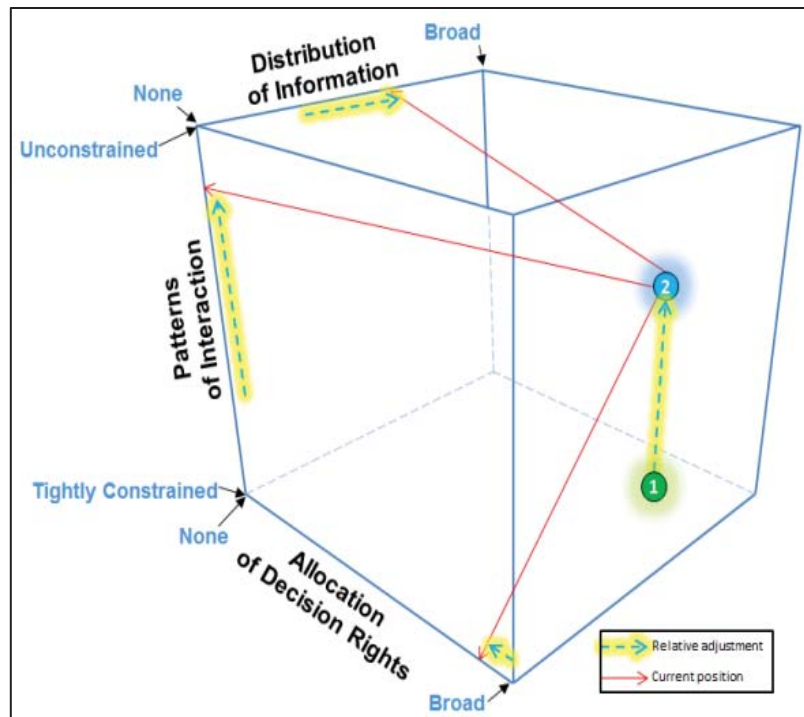

Figure A-7. C2 Approach Space after 24 Hours

organizations present. With distributed communication (and cell phone coverage) largely unavailable, the LNO network proved indispensable as the 1st SOG was limited to coordinating with each other on a 12-hour cycle during Col Elton's commander's update brief.

Within these first 24 hours Col Elton had already adapted his C2 approach (see Figure A-7) by increasing information sharing, albeit still limited in timeliness, and integration within the larger international effort.

While his initial guidance, to "assume you have the authority to do the right thing" still stood, through his update briefs Elton set two broad priorities: (a) keep the airfield open without a mishap, and (b) enable the gaps. He also stressed they were a part of the overall military force deployed in support of the lead U.S. Government agency, USAID, operating within a sovereign nation, at the request of that nation's government. It was imperative to Col Elton that his team put Haitians back in charge as soon as possible. This was to occur at all levels, to include something as simple as getting a Haitian controller on the Air Traffic Control radio. It didn't matter whose equipment it was, only that Haitians were once again able to conduct their nation's business. Reissuing commander's intent, focusing the team on the larger picture behind their operations, and establishing priorities helped unify the deployed team's actions.

After the first few days, Col Elton was once again able to adapt his C2 approach (Figure A-8). With an established battle-rhythm, a distributed LNO network, manning to

support full 24/7 operations, and, perhaps most importantly, the introduction of reliable communications technology, Elton now had the wherewithal to distribute information rapidly and increase the tempo of interactions with and among the various participating agencies (through LNOs). Reliable communication also allowed Col Elton to reserve more authority unto himself to make critical decisions, while continuing to allow his subordinates

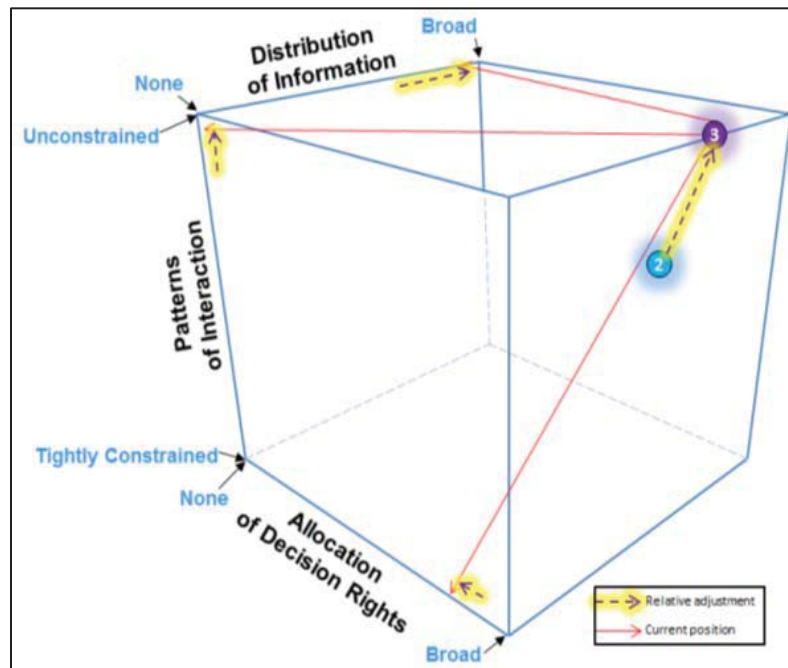

Figure A-8. C2 Approach Space, Communications Technology-enabled

the freedom of action to make on-the-spot calls they deemed necessary. Through the continuous adjustment of his C2 approach, Col Elton’s networked team remained agile enough to meet the continuously evolving challenges; however, this was met with some trepidation from outside the organization as the 1st SOG began outpacing the capability of the larger staffs supporting similar efforts. In situations he recognized as requiring both authority and risk acceptance well beyond his level, Col Elton utilized the linkages established with other deployed military and inter-agency senior leaders. In one example requiring the transport of refugees in a military plane, he talked directly to the then-National Security Council (NSC) Chief of Staff, who texted a request to the NSC/White House and received near-instantaneous direction. While greatly improving the tactical level execution, the team would occasionally get a “cease and desist” order from Flag officers who had to confirm the guidance Col Elton was receiving first-hand. This example highlighted the ability of a single agile organization to compensate for a lack of agility within the larger organization and the associated challenges faced under those circumstances.

Though the team was deft at applying C2 Agility throughout the initial stages of the operation, one of the most crucial aspects of their success was not only knowing who they were and what they were capable of, but arguably more important was their understanding of who they were not. By their very nature, special operations forces are employed as the crisis response force and are not organized, trained or equipped for long-term, large-scale steady state operations. Col Elton once again adjusted his C2 approach as additional capability was brought in by the Contingency Response Group (CRG), whose purpose is to sustain austere airfield operations (Figure A-9).

With the size and scope of his responsibility decreased, Col Elton began to transition LNO coordination efforts to the CRG and re-allocated decision making authorities to more senior leadership through the final redeployment. In the end, the 1st SOG successfully responded to an emerging crisis and opened an airfield crippled by the devastating

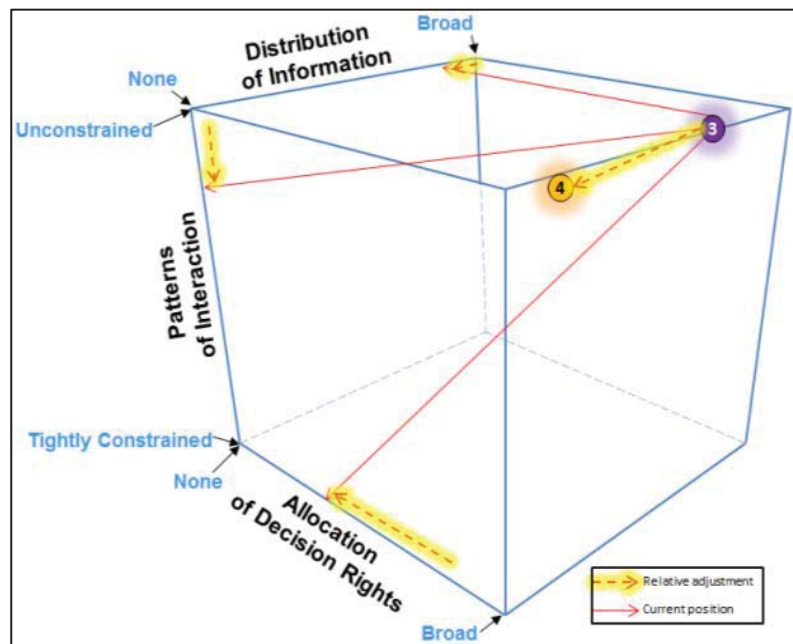

Figure A-9. C2 Approach Space during Transition

earthquake. By adjusting their C2 approach to match changing circumstances and demonstrating a propensity for agility throughout, these Air Commandos met their commander’s intent by filling the void and by aggressively acting where needed the most.

C2 Agility Summary: Though specifically organized, trained and equipped to respond globally to emerging combat crises, the Air Commandos of the 1st Special Operations Group demonstrated exceptional agility throughout their support of the 2010 Haiti earthquake international relief effort. Despite limited connectivity and a fragmented group of international support agencies, Col Elton adjusted his C2 method throughout the operation to match ever-evolving circumstances (Figure A-10). Though he states they were “uniquely prepared” for this event as a result of their recently concluded exercise, the very nature of that exercise is proof positive that a force can effectively train with agility in mind. Their success was further enabled by the authority to execute distributed operations starting from the AFSOC Commander’s simple guidance to “do good” and translated down to the lowest subordinate as “Assume you have the authority to do the right thing.” The unit was able to adjust their organization to accommodate the needs of a robust LNO network and adapt to learning new ways of conducting missions in light of the constraints applied throughout the operation. Throughout, Col Elton demonstrated the importance of being proactive in approaching C2 by adjusting not only delegated authorities, but also adjusting the organization and activities of his military network within the context of the overall international relief effort.

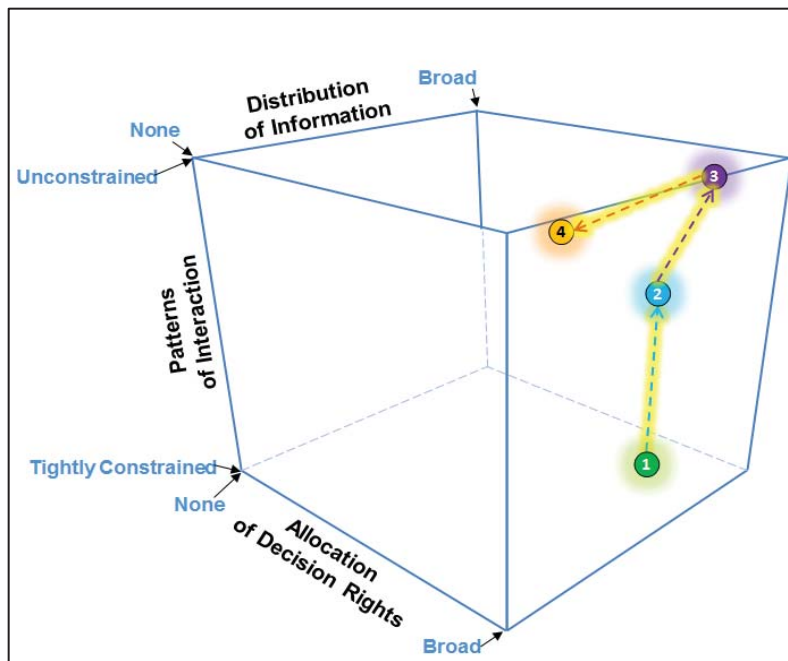

Figure A-10. Changes to C2 Approach Space as Circumstances Changed

I. Combined Joint Task Force -7 (CJTF-7) & the Coalition Provisional Authority (CPA): C2 as Afterthought

The invasion (aka ‘shock and awe’) phase of Operation Iraqi Freedom (OIF) lasted from 19/20 March until 30 April 2003. On 1 May, President Bush gave his ‘mission accomplished’ speech aboard the Abraham Lincoln. The command and control (C2) arrangements for this initial conventional phase of OIF followed well-established doctrine and were both appropriate and successful. Unfortunately, the same cannot be said about C2 for the next phase of OIF, commonly referred to as Phase IV. That the U.S. command was poorly prepared for a transition from combat to stabilization operations in the aftermath of the conventional combat phase of the invasion is well known. Less understood is the significance of the lack of a well-thought-out C2 approach, one that was more appropriate for the stabilization of Iraq; the haphazard implementation of that already flawed approach; the failure to adequately support the poorly designed C2 approach; the failure to recognize that C2 was problematic; and the failure rapidly to adapt the C2 approach to the changed circumstances once its inadequacies were recognized.⁷⁷ These C2 failures clearly contributed to the stumbling implementation of the stabilization effort by the United States and its coalition partners during the first year of occupation. It was during this period that the insurgency began to develop roots and blossom, and the lack of effective C2 arrangements in this critical timeframe resulted in missed opportunities to nip both foreseen and emerging problems in the bud.

1. Inadequate planning for Phase IV C2:

The United States Government (USG) overall, the Office of the Secretary of Defense (OSD), the Joint Staff, and U.S. Central Command (CENTCOM) planning for Phase IV was disjointed from the beginning. Planning that did take place reflected numerous disagreements over the conditions that would exist at the outset of the stabilization phase, assumptions about potential problem areas, resource requirements, and, most importantly, how the USG would manage the effort.⁷⁸ As a result “what was missing was a comprehensive blueprint to administer and restore Iraq after Saddam was deposed and identification of the U.S. organizations that would be installed in Baghdad to carry it out.”⁷⁹ The plan for Phase IV (eventually labelled ECLIPSE II) that was developed by the Coalition Forces Land Component Command (CFLCC) staff (a small cell in C-5) was

⁷⁷ For examples of other military operations that exhibited similar C2 failures, see Marius S. Vassiliou, David S. Alberts and Jonathan Russell Agre, *C2 Re-envisioned: The Future of the Enterprise* (Boca Raton, Florida: CRC Press, 2014).

⁷⁸ Gordon, Michael R. and Trainor, Bernard E., *Cobra II: The Inside Story of the Invasion and Occupation of Iraq* (New York: Pantheon Books, 2006), 138-163.

⁷⁹ Gordon and Trainor, 138.

given inadequate attention by leadership at CENTCOM, the Joint Staff, and OSD until after the fall of Baghdad and, importantly, such planning as was accomplished was based on best case assumptions.⁸⁰ It fell far short of a full operational design effort and was predicated upon a sketchy operational approach.⁸¹ It was assumed that C2 for these forces during the transition would be residuals of the C2 arrangements for Phase III, primarily that of the CFLCC.⁸² The erroneous assumptions underpinning Phase IV planning led General Franks, the CENTCOM commander, to announce to the OIF leadership in Baghdad on 16 April that a new functioning Iraqi government would exist within sixty days and that forces then in place should be prepared to pull out by then, to be replaced by follow-on forces which themselves would be there no more than four months.⁸³ Only after the stabilization phase actually began in May 2003 did it become apparent to both civilian and military senior leadership that a hand-over to Iraqis would take much longer.⁸⁴ That certainly implied that follow-on U.S. and coalition civilian and military C2 arrangements were needed until control of Iraq could be transferred to a new Iraqi government.

2. New C2 for Phase IV:

The new C2 arrangements for Phase IV were not determined through any deliberate process, let alone design. They were the result of *ad hoc* decisions by leadership intent on rapid disengagement⁸⁵ and without regard for the circumstances on the ground, circumstances that were becoming both worse and more evident daily. Driven primarily by the Secretary of Defense (SecDef), Washington decided upon a bifurcated civil/military structure with the civilian side, called the Coalition Provisional Authority (CPA), reporting directly to the SecDef and the military side, Coalition Joint Task Force Seven (CJTF-7), reporting to CENTCOM. Unity of command did not exist⁸⁶ and unity of effort would depend upon cooperation between the two organizations on the ground and on

⁸⁰ Donald Wright and Timothy R. Reese, *On Point II: Transition to a New Campaign: OIF May 2003-January 2005* (Fort Leavenworth, Kansas: Combat Studies Institute, 2008) 27; and Kevin Benson, "Phase IV Stability Operations Planning" in Brian De Toy, ed., *Turning Victory into Success: Military Operations after the Campaign* (Fort Leavenworth: Combat Studies Institute, 2004), 189.

⁸¹ Nora Bensahel, Olga Oliker, Keith Crane, Rick Brennan, Jr., Heather S. Gregg, Thomas Sullivan, and Andrew Rathmell. *After Saddam: Prewar Planning and the Occupation of Iraq* (RAND, 2008) 10-19; also see Gordon and Trainor, 463-472.

⁸² Benson, 187; Gordon and Trainor, 459.

⁸³ Wright and Reese, 27-28; Gordon and Trainor, 459.

⁸⁴ Many staff level officers, however, realized immediately that General Franks' policy announcement was unrealistic. Gordon and Trainor, 459.

⁸⁵ Wright, and Reese, 27-28.

⁸⁶ Ricks, Thomas E., *Fiasco: The American Military Adventure in Iraq* (New York: The Penguin Press, 2006), 174-175, 179-180, 265.

CENTCOM's interactions with the Joint Staff and OSD. The CFLCC was redesignated CJTF-7 on 1 May. It retained this designation only through 15 June when responsibilities and missions were transferred to V Corps, which had been one of its subordinate headquarters up to that point. V Corps headquarters was significantly different in size and composition from the organization it replaced and was ill-prepared to assume all the CFLCC functions.⁸⁷ On 21 April, the Office of Reconstruction and Humanitarian Assistance (ORHA), then headed by retired Army Lieutenant General Jay Garner, was redesignated the CPA.⁸⁸ Garner was replaced on 6 May by Ambassador Paul Bremer. The CPA in effect assumed all the authorities of the Iraqi government and retained those authorities from the time of its inception on 21 April 2003 until its dissolution on 28 June 2004. However, for the security function, initially the critical component of its responsibilities, the CPA depended on CJTF-7, which it did not control directly.⁸⁹

3. Haphazard C2 implementation and poor institutional support:

Exacerbating the adoption of an inappropriate approach to C2, neither the CPA nor CJTF-7 ever received the manpower support from their parent organizations needed for success. V Corps, when it became CJTF-7, inherited the mission and responsibilities of the CFLCC but without the structure or the people it needed for a seamless transition. Instead, virtually all the CFLCC personnel, who had already been deployed for an extended period, packed up and departed. With their departure, much-needed institutional knowledge of Iraq and operations up to that point was lost. Critically, this included knowledge of the network of linkages inside Iraq with other coalition organizations, the CPA and the Iraqis, as well as linkages with CENTCOM, other parts of the USG, and even academia.⁹⁰ To compound that problem, V Corps headquarters also had large numbers of personnel beginning to depart due to normal rotations. The majority of these were not replaced immediately. In fact, a month after assuming its role, the headquarters was manned at only 37 percent of authorizations; and only one of 30 critical requirements had been filled.⁹¹ Indeed, even by December the headquarters was manned at only 60 percent of the 1000 personnel then

⁸⁷ Wright, and Reese, 29-30; Ricardo Sanchez, LTG, USA, with Donald T. Phillips, *Wiser in Battle: A Soldier's Story* (New York: HarperCollins, 2008), 180-181, 198-199.

⁸⁸ ORHA had been established in December 2002, also as an afterthought. During its brief existence it suffered from bureaucratic infighting, was planning for a different set of conditions than those encountered, and was not resourced sufficiently to have any significant effect before it was replaced by the CPA.

⁸⁹ Ninety eight percent of official U.S. personnel in Iraq were not under Bremer's direct authority. James Dobbins, Seth G. Jones, Benjamin Runkle, and Siddharth Mohandas, *Occupying Iraq: A History of the Coalition Provisional Authority* (RAND, 2009), xiii

⁹⁰ Sanchez, 180; Ricks, 157.

⁹¹ Sanchez, 209.

authorized,⁹² while at the same time it was proposing that the structure really needed (which eventually was approved) was 1700 personnel.⁹³ CJTF-7 (V Corps), despite its important role, therefore was required by its parent institutions to undertake its mission with severe handicaps. Basically, it started nearly from scratch.⁹⁴ The CPA suffered from similar, perhaps even worse, handicaps. It was habitually undermanned.⁹⁵ Many of its positions were filled by people who were eager but lacked experience requisite to their jobs, and often they were on only short-term assignments of three to six months, sometimes leaving without replacement. CPA shortages were particularly acute in its four regional offices, with one manned at only 20 percent.⁹⁶ Because of these shortfalls, the CPA was unable to perform many of its tasks.⁹⁷ The military was often called upon to fill CPA gaps, diverting uniformed personnel from their CJTF-7 security responsibilities.⁹⁸ And to exacerbate the already tenuous C2 structure, which depended on cooperation between the two components in Iraq, each with a separate chain of command, the individuals heading the two organizations were not on good terms; and cooperation in general between the organizations was tenuous.⁹⁹ Finally, whether the CPA head, Paul Bremer, was actually accountable to anyone in the USG is an open question.¹⁰⁰ At this point it should be noted that even if the adopted C2 approach had been appropriate for the mission and circumstances, the change in personnel should have triggered a review and a search for a more appropriate C2 approach that took into consideration the capabilities of the staff necessary to support it.

⁹² According to a former Army Chief of Military History, CJTF-7 headquarters grew to include 19 general officers, and its overall officer and NCO strength more than tripled, from about 300 to nearly 1,000. However, "it took a year to get things right." Many staff sections averaged about 50-percent fill for months, and the Services filled many of the Individual Augmentation positions on a very short-term basis; some were deployed to CJTF-7 for tours of as little as 30 days. John S. Brown, BG, USA (Ret.), "Do We Need an Iraqi Freedom Elevator Speech?" *Army, the Magazine of the Association of the United States Army*. Volume 63, Number 2, February 2013, 24.

⁹³ Sanchez, 290-291.

⁹⁴ Gordon and Trainor, 475-496.

⁹⁵ Terrence Kelly, Ellen E. Tunstall, Thomas S. Szayna, and Deanna Weber Prine, *Stabilization and Reconstruction Staffing: Developing U.S. Civilian Personnel Capabilities*, (RAND, 2008), 11-18; Sanchez, 312.

⁹⁶ Ricks, 212.

⁹⁷ Ricks, 111; 203-213; Sanchez, 197.

⁹⁸ Sanchez, 210.

⁹⁹ Ricks, 179-181; Gordon and Trainor, 488.

¹⁰⁰ Dobbins et al, xvii-xix.

4. Failure to rapidly adapt C2:

Many in the military, especially in CJTF-7 but also in CENTCOM, immediately recognized that the fuzzy concept for Phase IV, including the C2 approach, was flawed given the facts on the ground and the inaccurate assumptions on which the concept was based. It was clear that actual circumstances required a different C2 approach, yet it took a costly year to adapt the flawed C2 approach to something better aligned with the Phase IV operational needs. As early as May 2003, an alternate C2 approach, better suited to operational requirements, was being discussed. It was recognized that CJTF-7 needed to split the CJTF-7 headquarters into two parts, with “one at the CPA with a theater strategic- and operational-level focus ... and the other with a warfighting tactical focus.”¹⁰¹ However, shortages of personnel diluted the C2 capacity on both ends; and serious C2 shortcomings remained well into 2004. The revised C2 approach that eventually got approved converted CJTF-7 into two separate entities on 15 May 2004. Multi-National Force Iraq (MNF-I), led by a four-star, was focused on the theater-strategic level and, in coordination with the U.S. embassy, took on many of the CPA responsibilities. Multi-National Corps Iraq (MNC-I), led by a three-star, was the operational/tactical headquarters controlling the forces involved in counter-insurgency. It took until the end of 2003 to convince the Joint Staff, the Services, and OSD that this new arrangement was needed; and then, even after the Joint Manning Documents were approved, the two headquarters were not manned to 90 percent until about June 2004.¹⁰² At the end of June 2004, the CPA was disestablished and U.S. civilian operations in Iraq became the responsibility of the new Ambassador. This improved C2 approach existed until 2010. By all accounts it was reasonably successful in dealing with myriad challenges through late 2009, when it morphed again as the drawdown began.

5. The consequences:

It is generally agreed that during the period between May 2003 and June 2004 the U.S.-led coalition missed the opportunity to gain control of the Phase IV situation.¹⁰³ Coalition casualties during this period included 809 killed compared to 192 during the first six weeks of the war. The following year, 954 were killed as conditions deteriorated.¹⁰⁴ If opportunities existed during this period to arrest the movement to chaos, the inept C2

¹⁰¹ Sanchez, 181, 189, 194.

¹⁰² Sanchez, 400; Ricks, 149.

¹⁰³ Gordon and Trainor, 493; Ricks, 341; Sir Jeremy Greenstock, as quoted in Cullen Murphy and Todd S. Purdum, “Farewell to All That: An Oral History of the Bush White House,” (*Vanity Fair*, February 2009).

¹⁰⁴ <http://icasualties.org/iraq/ByMonth.aspx>.

arrangements all but eliminated the possibility of taking advantage of them.¹⁰⁵ The cavalier attitudes and decisions made in April/May 2003 about follow-on C2 for Phase IV were egregious failures by those entrusted with command, especially the senior military whose profession relies fundamentally on C2. Failure to design a C2 approach appropriate to the mission and circumstances, and then failure to resource the C2 structure in a timely fashion, significantly hampered both the CPA and CJTF-7 as they attempted first to figure out what to do and then pursued their chosen courses of action. Ultimately, history will judge whether either one was marginally effective or both were simply outright failures; but that C2 was botched in this critical period is not in doubt.

C2 Agility Summary: Many of difficulties encountered during the first year of coalition stability operations in Iraq can be traced to a flawed C2 approach. It was flawed because little attention was given to what was required and the C2 arrangements decided upon were essentially an afterthought. Clearly there was no design process nor was there an operational approach around which a supportive C2 approach might have emerged. Moreover, even the flawed C2 approach was hampered by lack of institutional support to meet the minimum staffing needs of both the CPA and CJTF-7 or to improve the C2 arrangements. It is probable that had some process like operational design been applied, a clearer operational approach would have been developed that led naturally to an appropriate C2 approach, one that could support the operational approach. At a minimum, such a planning process could have helped CJTF-7 make a stronger case for a change in the C2 approach, thereby accelerating the eventual adaptation to what was actually needed for successful operations. What is certain it that, necessary attention to and structured thinking about C2 obviously were missing when they were sorely needed.

¹⁰⁵ For example it has been asserted that CJTF-7 never issued a campaign plan for Phase IV. Ricks, 225-226.

Appendix B

The 7-Minute and 10-Minute Drills

The “7-Minute Drill” has been in use since at least 2006, when it was recognized by the Joint Warfighting Center as a “Best Practice” for keeping the boards, bureaus, centers, cells, and working groups (B2C2WG) in a joint headquarters down to the number needed to support command decision making. The “7-Minute Drill” was described as follows:

We’ve seen the extensive use of B2C2WGs in every joint headquarters. These functional integrating structures provide the forums for bringing together the various expertises of the staff focused on specific problem sets to provide coherent staff recommendations to the commander. They make staff coordination more routine, increase cross-functional integration, facilitate monitoring, assessment, and planning, provide venues for command decisions, and allow for the management of current operations, future operations, and future plans. These boards are physical venues but also support virtual collaboration and participation with other stakeholders and headquarters.

<p><i>7-Minute Drill</i></p> <ol style="list-style-type: none">1. Name of board or cell:2. Lead J code:3. When / where does it meet in Battle Rhythm?4. Purpose:5. Inputs required from:6. When?7. Output / Process / Product:8. Time of delivery:9. Membership codes: <p style="text-align: right;">12</p>
--

Figure B-1. 7-Minute Drill

We observe a continuing challenge in the staffs on balancing the potentially large number of B2C2WGs necessary for full staff analysis and integration with the limited

number of personnel on the staff, time available, and other competing scheduling requirements for the principals and leaders. A number of chiefs of staff of the various joint headquarters have forced discipline on the numbers of B2C2WGs by requiring the staff proponent to defend the need for the B2C2WG in terms of what it brings to the decision cycle (in terms of specific inputs, outputs, and recipients of that information).

Several chiefs of staff use the ‘7-minute drill’ [Figure B-1] to vet B2C2WGs. The 7-minute drill is a means by the staff proponent summarizes the purpose for the appropriate B2C2WG, its linkage to other B2C2WGs, and its support to decision making requirements.¹⁰⁶

Proposed “10-Minute Drill”

JTF or General Staff C2 Activity Name: _____

Are we doing the right things?	<ol style="list-style-type: none">1. <i>Understanding the problem:</i> What is the overarching purpose of the operation? What is your understanding of what is both desirable and attainable in the grandest sense?2. <i>Understanding the context:</i> What, then, is the purpose of this C2 activity? What is this C2 activity’s relationship to the overarching purpose and your role in support of the operational approach (or LOE supporting it)?3. <i>Linkages:</i> When, where, and how does this activity meet?4. <i>Linkages:</i> Who is in charge of meetings and who attends meetings? Should others attend? If so, who and why?5. <i>Information Distribution:</i> What are the inputs to this activity? How are these inputs delivered or obtained? Who do you expect to provide these inputs?
Are we doing things right?	<ol style="list-style-type: none">6. <i>Information Distribution:</i> What are the outputs from this activity? <i>Decision Rights:</i> Who can release these outputs?7. <i>Information Distribution:</i> Are there larger processes that this activity serves? If so, what are they? What and when do these processes require inputs from this activity? <i>Linkages:</i> Who uses and how do they use these inputs?8. <i>Assess:</i> What has changed or could change that affects 2-7 above?9. <i>Assess:</i> Can this activity be improved? If so, how?10. <i>Assess:</i> Do you have other concerns? If so, briefly explain.

Figure B-2. Proposed “10-Minute Drill”

The “10-Minute Drill” is a proposed enhancement of the “7-Minute Drill.” If adopted for use by JTF staffs, the “10-Minute Drill” would replace the shorter exercise. It serves the original purpose of the “7 Minute Drill” and adds a line of inquiry that can be used by

¹⁰⁶ Gary Luck, General, USA (Ret.), *Insights on Joint Operations: The Art and Science* (Suffolk, VA: Joint Warfighting Center, U.S. Joint Forces Command, September 2006), 28-29.

the headquarters battle rhythm manager (Chief of Staff or Deputy Commander, potentially supported by a separate C2 Assessment Cell) to align each C2 activity (including B2C2WG) with the appropriate C2 approach, whether that means the one currently being practiced or one anticipated based upon future operations.

It is envisioned that every C2 activity owner would conduct the “10-Minute Drill” on a daily basis. The chief of staff should consider tasking at least one C2 activity owner (e.g., the Targeting Work Group) each day to review the results of their 10-Minute Drill as part of the battle rhythm scrub. All C2 activity owners present would listen, participate, and learn from the presentation, thereby informing appropriate adjustments to their own “10-Minute Drill.” This would have the effect of shaping the C2 approach across the headquarters.

Approved for public release; distribution is unlimited.

Approved for public release; distribution is unlimited.

Appendix C Illustrations

Figures

Figure 1. C2 Approach Space	4
Figure 2. C2 Agility	5
Figure 3. C2 Agility is Intentional Movement within the C2 Approach Space	6
Figure 4. Developing the Operational Approach and the C2 Approach	9
Figure 5. Operational Approach—Example.....	11
Figure 6. Developing the C2 Approach	14
Figure 7. Joint C2 Terms.....	16
Figure 8. Operational Approach and C2 Approach	17
Figure 9. PMESII (Political, Military, Economic, Social, Information, and Infrastructure) System Analysis	26
Figure 10. Sub-system Level Assessment.....	33
Figure A-1. Divisions of British Airspace by Group	A-6
Figure A-2. UNITAF Force Structure.....	A-10
Figure A-3. UNITAF’s External Linkages	A-11
Figure A-4. Battalion-level Battlespace Geometry	A-17
Figure A-5. The German Offensive, 30 August - 5 September	A-22
Figure A-6. C2 Approach Space, upon Initial Deployment	A-26
Figure A-7. C2 Approach Space after 24 Hours	A-27
Figure A-8. C2 Approach Space, Communications Technology-enabled	A-28
Figure A-9. C2 Approach Space during Transition.....	A-29
Figure A-10. Changes to C2 Approach Space as Circumstances Changed	A-30
Figure B-1. 7-Minute Drill.....	B-1
Figure B-2. Proposed “10-Minute Drill”	B-2

Tables

Table 1. Joint C2 Tasks and Exemplar C2 Activities	20
Table 2. Key Elements of Macro-level Assessment and Red Teaming.....	32

Approved for public release; distribution is unlimited.

Approved for public release; distribution is unlimited.

Appendix D

References

- Alberts, David S., and Richard E. Hayes. *The Future of Command and Control: Planning Complex Endeavors*. Department of Defense Command and Control Research Program, April 2007.
- Allard, Kenneth. *Somalia Operations: Lessons Learned*. CCRP Publication, 1995.
- “Battle of Trafalgar,” Wikipedia, The Free Encyclopedia, accessed January 22, 2014.
http://en.wikipedia.org/w/index.php?title=Battle_of_Trafalgar&oldid=590724309
- Bensahel, Nora, Olga Olikier, Keith Crane, Rick Brennan, Jr., Heather S. Gregg, Thomas Sullivan, and Andrew Rathmell. *After Saddam: Prewar Planning and the Occupation of Iraq*. RAND, 2008.
- Benson, Kevin. “Phase IV” *Stability Operations Planning*, in Brian De Toy, ed., *Turning Victory into Success: Military Operations after the Campaign*. Fort Leavenworth: Combat Studies Institute, 2004.
- Brown, John S., BG, USA (Ret.). “Do We Need an Iraqi Freedom Elevator Speech?” *Army, the Magazine of the Association of the United States Army*. Volume 63, Number 2, February 2013.
- Chairman of the Joint Chiefs of Staff, *Mission Command White Paper*, 2 April 2012.
http://www.dtic.mil/doctrine/concepts/white_papers/cjcs_wp_missioncommand.pdf
- Commandant of the Marine Corps. Marine Corps Doctrinal Publication 6, *Command and Control*, 4 October 1996.
- Corbett, Julian Stafford. *The Campaign of Trafalgar* 2 vols. London, New York: Longmans, Green and Co., 1919; republished by Nonsuch Publishing, 2005.
- Department of the Army. Army Doctrine Reference Publication 5-0, *The Operations Process*, May 2012.
http://armypubs.army.mil/doctrine/DR_pubs/dr_a/pdf/adrp5_0.pdf
- Dobbins, James, Seth G. Jones, Benjamin Runkle, and Siddharth Mohandas. *Occupying Iraq: A History of the Coalition Provisional Authority*. RAND, 2009.
- Fuhrmann, Matthew, Nathan Edwards, and Michael Salomone. “The German offensive of 1914: A new perspective,” *Defense & Security Analysis*, 21:1, 2005.
- Garamone, Jim. “ISAF Chief Briefs Reservists on Afghan Progress, Future,” U.S. Department of Defense, American Forces Press Service, August 8, 2013.
<http://www.defense.gov/News/newsarticle.aspx?ID=120598>.
- Gordon, Michael R. and Bernard E., Trainor. *Cobra II: The Inside Story of the Invasion and Occupation of Iraq*. New York: Pantheon Books, 2006).
- Joint Staff. “Insights and Best Practices.” Accessed 28 July 2014,
http://www.dtic.mil/doctrine/fp/focus_papers.htm

- Joint Staff. Joint Publication (Pub) 1, *Doctrine for the Armed Forces of the United States*, 15 March 2013. http://www.dtic.mil/doctrine/new_pubs/jp1.pdf.
- Joint Staff. Joint Pub 1-02, *Department of Defense Dictionary of Military and Associated Terms*. 8 November 2010 (As Amended Through 15 July 2015). http://www.dtic.mil/doctrine/new_pubs/jp1_02.pdf.
- Joint Staff. Joint Pub 3-0, *Joint Operations*, 11 August 2011, http://www.dtic.mil/doctrine/new_pubs/jp3_0.pdf
- Joint Staff. Joint Pub 5-0, *Joint Operation Planning*, 11 August 2011, http://www.dtic.mil/doctrine/new_pubs/jp5_0.pdf
- Keegan, John. *The Price of Admiralty* (London: Hutchinson, 1988).
- Kelly, Terrence, Ellen E. Tunstall, Thomas S. Szayna, and Deanna Webber Payne. *Stabilization and Reconstruction Staffing*. RAND, 2008
- Kolenda, Christopher. "How can we avoid losing more wars? Start by putting somebody in charge of them" at Tom Ricks' "Best Defense" blog on the foreignpolicy.com website, January 13, 2015.
- Korda, Michael. *With Wings like Eagles*. New York: Harper Perennial, 2009.
- Luck, General Gary, U.S. Army (Retired). *Insights on Joint Operations: The Art and Science*. Joint Warfighting Center, U.S. Joint Forces Command, September 2006.
- McChrystal, Lieutenant General Stanley A., U.S. Army. "Becoming the Enemy," *Foreign Policy*, No. 185 (2011): 66-70.
- McFarland, Jenny, Dan McConnell, Harvey Reed, and John Kane, *Modeling C2 Agility to Meet the Demands of a Distributed Force*. Paper presented at 18th International Command and Control Research and Technology Symposium, 26 April 2013. http://www.dodccrp.org/events/18th_iccrts_2013/post_conference/papers/014.pdf.
- Murphy, Cullen and Todd S. Purdum. "Farewell to All That: An Oral History of the Bush White House," *Vanity Fair*, February 2009, accessed 29 September 2015. <http://www.vanityfair.com/news/2009/02/bush-oral-history200902>
- NATO NEC C2 Maturity Model. Washington DC: CCRP, 2010. http://www.dodccrp.org/html4/books_main.html.
- Perkins, Lieutenant General David, U.S. Army. "Developing Competent and Committed Leaders Capable of Executing Army's Doctrine 2015," *CGSC Foundation News*, No 15/Fall 2013.
- Ricks, Thomas E. *Fiasco: The American Military Adventure in Iraq*. New York: The Penguin Press, 2006.
- Royal Museums Greenwich, "Quotations, Vice-Admiral Horatio, Lord Nelson," accessed 28 July 2014, <http://www.rmg.co.uk/explore/sea-and-ships/in-depth/nelson-a-z/quotations>.
- Salanitri, Senior Airman David, Air Force Special Operations Command Public Affairs, "AFSOC Airmen save Haitian earthquake victim, land more than 600 aircraft on

island,” *Air Force Times*, 1/17/2010, accessed 25 July 2014.
<http://www.afsoc.af.mil/news/story.asp?id=123186022>,

Sanchez, Ricardo S., Lieutenant General, U.S. Army (Retired) with Donald T. Phillips, *Wiser in Battle: A Soldier's Story*. New York: HarperCollins, 2008.

Stewart, Richard W. *The U.S. Army in Somalia: 1992-1994*, Center for Military History Online Pub 70-81-1, 2003.

Vassiliou, Marius S., David S. Alberts, and Jonathan R. Agre. *C2 Re-envisioned: The Future of the Enterprise*. Washington: CRC Press, 2014.

West, Bing. *The Strongest Tribe*. New York: Random House, 2008.

Wright, Donald and Timothy R. Reese. *On Point II: Transition to a New Campaign: OIF May 2003-January 2005*. Fort Leavenworth: Combat Studies Institute, 2008.

United States Census Bureau, “Census Data & Emergency Preparedness, Earthquake in Haiti,” accessed 11 August 2014.
https://www.census.gov/newsroom/emergencies/earthquake_in_haiti.html .

USAF Special Operations School, “Unified Response: JSOAC-Haiti.” Undated Power Point presentation.

Approved for public release; distribution is unlimited.

Approved for public release; distribution is unlimited.

Appendix E

Abbreviations

ABP	Afghan Border Police
AFSOC/CC	Air Force Special Operations Command/ Commander
ANA	Afghan National Army
ANSF	Afghan National Security Forces
AO	area of operations
AOC	air operations center
AUP	Afghan Uniform Police
B2C2WG	boards, bureaus, centers, cells, and working groups
BCT	brigade combat team
C2	command and control
CCRP	Command and Control Research Program
CENTCOM	U.S. Central Command
CFLCC	coalition forces land component command
CGSC	Command and General Staff College (U.S. Army)
CJIATF	commander, joint inter-agency task force
CJSOTF	commander, joint special operations task force
CJTF	combined joint task force; commander, joint task force
CMOC	civil-military operations center
COA	Course of Action
COL	Colonel (U.S. Army)
COP	common operational picture
CPA	Coalition Provisional Authority
CRG	contingency response group
DOD	Department of Defense
DOTMLPF-P	doctrine, organization, training, materiel, leadership and education, personnel, facilities, and policy

F3EA	find, fix, finish, exploit, and analyze
GPS	Global Positioning System
HANDCON	A command relationship or linkage negotiated between parties and sealed with a handshake
HQ	headquarters
IMEF	First Marine Expeditionary Force
ISAF	International Security Assistance Force
JFACC	joint force air component commander
JOPP	joint operation planning process
JSOAC-H	Joint Special Operations Air Component – Haiti
JSOTF	joint special operations task force
JTF	joint task force
LNO	liaison officer
LOE	line of effort
LOO	line of operation
MEU	Marine expeditionary unit
MiTT	Military Transition Team
MNC-I	Multi-National Corps – Iraq
MNF-I	Multi-National Force - Iraq
NGO	nongovernmental organization
NCA	national command authorities
OEF	Operation Enduring Freedom
OGA	other government agencies
OIF	Operation Iraqi Freedom
OSD	Office of the Secretary of Defense
OPCON	operational control
ORHA	Office of Reconstruction and Humanitarian Assistance
PMESII	political, military, economic, social, information, and infrastructure
Pol-Mil	political-military
PRT	provincial reconstruction team

PSYOP	psychological operations
Pub	publication
RAF	Royal Air Force (UK)
RC-E	Regional Command – East
RCT	regimental combat team
SecDef	Secretary of Defense
SFAAT	Security Forces Advise and Assist Team
SOCSOUTH/CC	Special Operations Command, Southern Command/Commander
SOF	special operations forces
SOG	special operations group
TACON	tactical control
TF	task force
UNITAF	Unified Task Force
UNOSOM	United Nations Operations in Somalia
U.S.	United States
USAID	United States Agency for International Development
USCINCCENT	United States Commander in Chief, Central Command
USG	United States Government
VBIED	vehicle-borne improvised explosive device

Approved for public release; distribution is unlimited.

Approved for public release; distribution is unlimited.

REPORT DOCUMENTATION PAGE			Form Approved OMB No. 0704-0188		
Public reporting burden for this collection of information is estimated to average 1 hour per response, including the time for reviewing instructions, searching existing data sources, gathering and maintaining the data needed, and completing and reviewing this collection of information. Send comments regarding this burden estimate or any other aspect of this collection of information, including suggestions for reducing this burden to Department of Defense, Washington Headquarters Services, Directorate for Information Operations and Reports (0704-0188), 1215 Jefferson Davis Highway, Suite 1204, Arlington, VA 22202-4302. Respondents should be aware that notwithstanding any other provision of law, no person shall be subject to any penalty for failing to comply with a collection of information if it does not display a currently valid OMB control number. PLEASE DO NOT RETURN YOUR FORM TO THE ABOVE ADDRESS.					
1. REPORT DATE (DD-MM-YY) xx-09-2015		2. REPORT TYPE Final		3. DATES COVERED (From - To)	
4. TITLE AND SUBTITLE Command and Control by Design: Putting Command and Control Theory into Practice, Version 2.0			5a. CONTRACT NO.		
			5b. GRANT NO.		
			5c. PROGRAM ELEMENT NO(S).		
6. AUTHOR(S) David S. Alberts, Kathleen M. Conley, Waldo D. Freeman, James H. Kurtz, Mark E. Tillman			5d. PROJECT NO.		
			5e. TASK NO. C6414		
			5f. WORK UNIT NO.		
7. PERFORMING ORGANIZATION NAME(S) AND ADDRESS(ES) Institute for Defense Analyses 4850 Mark Center Drive Alexandria, VA 22311-1882			8. PERFORMING ORGANIZATION REPORT NO. IDA NS D-5614 H 2015-000978		
9. SPONSORING / MONITORING AGENCY NAME(S) AND ADDRESS(ES) Institute for Defense Analyses 4850 Mark Center Drive Alexandria, VA 22311-1882			10. SPONSOR'S / MONITOR'S ACRONYM(S)		
			11. SPONSOR'S / MONITOR'S REPORT NO(S).		
12. DISTRIBUTION / AVAILABILITY STATEMENT Approved for public release; distribution is unlimited.					
13. SUPPLEMENTARY NOTES					
14. ABSTRACT Command and control (C2) is said to be the means by which a commander recognizes what needs to be done and sees to it that appropriate actions are taken. Operational design methodology helps reduce uncertainty in a complex operational environment and enables the commander to develop an operational approach—a description of the broad actions the force must take to achieve the desired military end state. Executing the operational approach often involves actors and entities not under the authority of the commander, which calls for a tailored C2 approach that takes into account all the players important to mission success and that defines the nature of the linkages required. C2 Agility Theory holds that such a C2 approach can be characterized using three fundamental variables: (1) how decision rights are allocated; (2) how entities interact with one another; and (3) how information is distributed. This handbook has as its central premise that a unique and tailored C2 approach can and should be associated with every operational approach. It describes how the operational design process that produces the operational approach should be leveraged to develop a corresponding C2 approach. Both are based on prevailing circumstances and may need to be changed as circumstances change, necessitating continuous assessment of both the operational approach and the C2 approach.					
15. SUBJECT TERMS Command and control (C2), DoD Command and Control Research Program (CCRP), Command and Control Agility Theory, C2 approach space, Allocation of decision rights, Patterns of interaction, Distribution of information, Joint operation planning process (JOPP), Operational design, Commander's Planning Guidance, Operational approach, C2 approach, Assessing the C2 approach, C2 method, C2 activities, C2 linkages, Mission command, Joint Task Force, 7-minute drill, 10-minute drill.					
16. SECURITY CLASSIFICATION OF:			17. LIMITATION OF ABSTRACT UU	18. NO. OF PAGES 100	19a. NAME OF RESPONSIBLE PERSON David S. Alberts
a. REPORT U	b. ABSTRACT U	c. THIS PAGE U			19b. TELEPHONE NUMBER (Include Area Code) 703-845-2411

Approved for public release; distribution is unlimited.

Approved for public release; distribution is unlimited.